

AH diagnostics

AN EXTRAORDINARY ADVENTURE

TIPS, MICROPIPETTES



AH diagnostics A/S
Gammel Viborgvej 11A, 8381 Tilst, Denmark
order@ahdiagnostics.dk +45 8745 9010
<https://www.ahdiagnostics.dk/>

AN EXTRAORDINARY ADVENTURE



TIPS AND MICROPIPETTES

• EPPENDORF	
Micropipettes, epT.I.P.S. tips	481 to 488
• THERMO SCIENTIFIC	
Finnpipettes Micropipettes, multichannel micropipettes, Finntips tips	489 to 495
• GILSON	
PIPETMAN®, tips, accessories, MICROMAN®, DISTRIMAN®, REPETMAN®	496 to 500
• SARTORIUS BIOHIT <i>family</i>	
Micropipettes, multichannel micropipettes, eLine and tips	501 to 507
• SOCOREX	
Micropipettes	508 to 512
• CAPP	
Micropipettes	513
• BRAND	
Transferpette	514 and 515
• CLEARLINE®	
Micropipettes, tips	516 to 519, 525
• LABMATE	
Micropipettes	520
• BIOSIGMA	
Micropipettes	520
• Tips, pipettes MμLTI	521 to 524
• NEPTUNE CLP Tips	526 and 527
• ART Tips	528 to 530
• TREFF® Tips	531
• GREINER BIO-ONE Tips	532
• LABCON Tips	534 à 536
• Special tips	537 to 542
• Gel Tips	542 to 544
• Micropipette holder, Checkit pipette	545 to 548
• Positive displacement micropipettes	549 and 550
• Dispensing pipettes and syringes	551 to 557
• Benchtop Pipette Controllers	558 and 559
• Glass capillaries, microcaps, dispensing accessories	560 and 561
• Microinjector	562

Eppendorf micropipettes

Model	Eppendorf Research® plus	Eppendorf Reference® 2	Eppendorf Xplorer®/ Eppendorf Xplorer® plus	Eppendorf Research® plus Move It®/ Eppendorf Xplorer® plus Move It®
Operating mode	Manual	Manual	Electronic	Manual / Electronic
Adjustable spacing between tips	No	No	No	Yes
Highlights	Lightweight, low pipetting force	Single button operation	Efficient and accurate automated pipetting	Variable tip spacing for transfer between different formats
Volume range	0.1 µl - 10 ml	0.1 µl - 10 ml	0.5 µl - 10 ml	1 - 1200 µl
Available options	1 channel, 8 channel, 12 channel, 16 channel, 24 channel	1 channel, 8 channel, 12 channel	1 channel, 8 channels, 12 channel, 16 channel, 24 channel	4 channel, 6 channel, 8 channel, 12 channel
RFID tracking	Yes	Yes	Yes	Yes
Autoclavable parts	Entirely	Entirely	Lower part	Lower part

Eppendorf Research® plus Micropipettes

- **Lightweight pipette, minimises handling forces without reducing robustness**
 - **Tip-holder end with shock absorber reduces tip attachment forces to reduce muscle strain**
 - **Highly flexible piston for minimum effort during handling and strong to minimise wear**
 - **Clip-on disassembly/assembly system for easy maintenance**
 - **Integrated RFID chip provides simple identification and documentation**
 - **Fully autoclavable without disassembly**
- **2 versions:**
- **GLP (General Lab Product), for all applications other than human diagnosis**
 - **CE/IVD, for human clinical applications (human diagnosis)**



Eppendorf Research® plus Micropipettes - variable volume

Volume (µl)	Colour push button	Research® plus GLP		Research® plus CE/IVD	
		Cat. No.	Price	Cat. No.	Price
0.1 - 2.5	Anthracite	933953	N/A -	035602	N/A -
0.5 - 10	Grey	933954	N/A -	035603	N/A -
2 - 20	Light grey	933961	N/A -	035610	N/A -
2 - 20	Yellow	933955	N/A -	035604	N/A -
10 - 100	Yellow	933956	N/A -	035605	N/A -
20 - 200	Yellow	933957	N/A -	035606	N/A -
30 - 300	Orange	933962	N/A -	035611	N/A -
100 - 1000	Blue	933958	N/A -	035607	N/A -
250 - 2500	Red	934304	N/A -	934303	N/A -
500 - 5000	Violet	933959	N/A -	035608	N/A -
1000 - 10000	Turquoise	933960	N/A -	035609	N/A -



Eppendorf racks:
See page 488

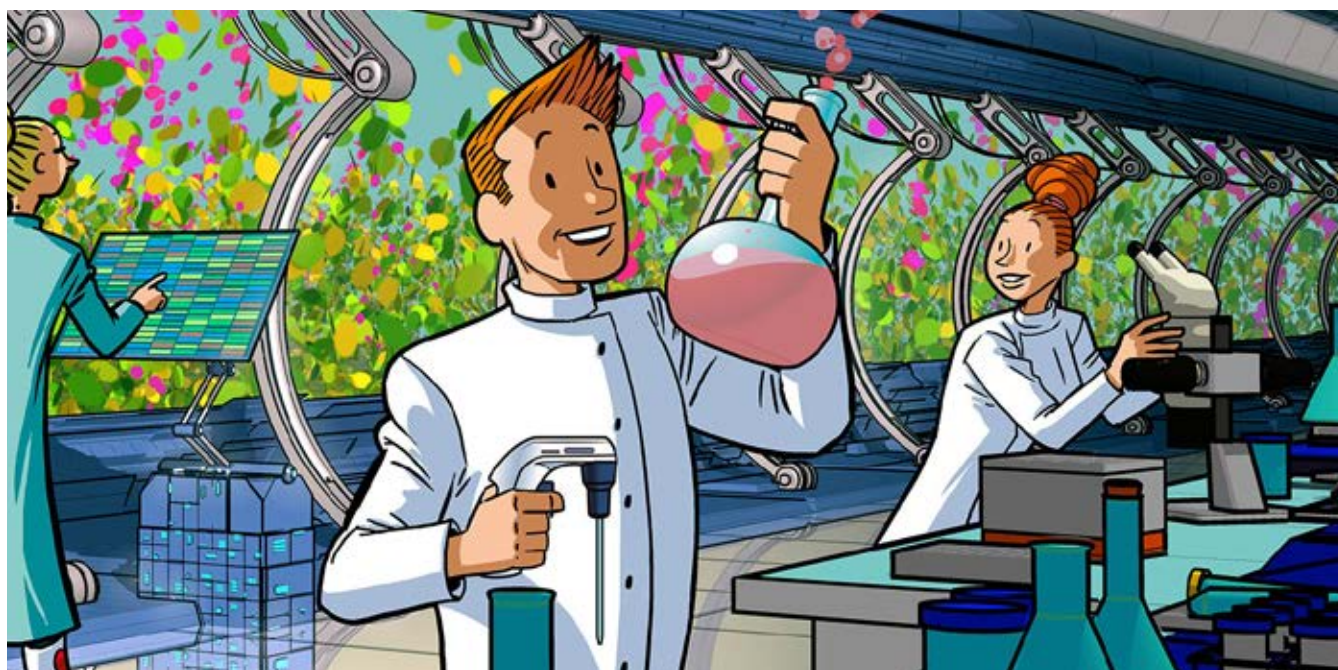

TIPS
MICROPIPETTES

Eppendorf Research® plus Micropipettes (continued)



Channel indicator

- Always use the pipette in the same way (left/right)

Tip-holder end with shock absorber

- Improved ergonomics
- Perfect adaptability to the tips

Eppendorf Research® plus Multi-channel micropipettes

Volume (µl)	Code Colour	8-channel				12-channel			
		Research® plus GLP		Research® plus CE/IVD		Research® plus GLP		Research® plus CE/IVD	
		Cat. No.	Price	Cat. No.	Price	Cat. No.	Price	Cat. No.	Price
0.5 - 10	Grey	933978	N/A -	035624	N/A -	933979	N/A -	035625	N/A -
10 - 100	Yellow	933980	N/A -	035626	N/A -	933981	N/A -	035627	N/A -
30 - 300	Orange	933982	N/A -	035628	N/A -	933983	N/A -	035629	N/A -
120 - 1200	Green	934370	N/A -	934368	N/A -	934371	N/A -	934369	N/A -

Eppendorf Research® plus Micropipettes 16 and 24 channel

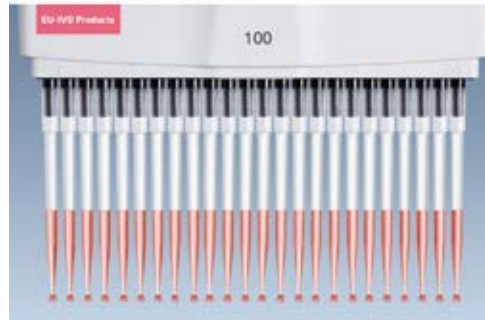

- Simplifies filling of 384-well microplates
- 4.5 mm spacing between the tips
- SOFTattach technology for better tip fixation
- SOFTject system for successive tip ejection, reducing ejection forces
- Only compatible with ep.T.I.P.S. tips. 384

Volume (µl)	Code Colour	16-channel				24-channel			
		Research® plus GLP		Research® plus CE/IVD		Research® plus GLP		Research® plus CE/IVD	
		Cat. No.	Price	Cat. No.	Price	Cat. No.	Price	Cat. No.	Price
1 - 20	Light pink	934327	N/A -	934323	N/A -	934328	N/A -	934324	N/A -
5 - 100	Light yellow	934329	N/A -	934325	N/A -	934330	N/A -	934326	N/A -



ep Research® plus Packs

		ep Research® plus Pack 1	ep Research® plus Pack 2	ep Research® plus Pack 3
	Includes	1 Research® plus 0.5 - 10 µl 1 Research® plus 10 - 100 µl 1 Research® plus 100 - 1000 µl 3 epTips box (10, 100 and 1000 µl)	1 Research® plus 2 - 20 µl 1 Research® plus 20 - 200 µl 1 Research® plus 100 - 1000 µl 3 epTips box (2 x 200 µl, 1 x 1000 µl)	1 Research® plus 0.1 - 1 ml 1 Research® plus 0.5 - 5 ml 1 Research® plus 1 - 10 ml 1 epTips box 1 ml Bags with 5 ml and 10 ml tips
Research® plus GLP	Cat. No.	933963	933964	933965
	Price	N/A -	N/A -	N/A -
Research® plus CE/IVD	Cat. No.	035636	035637	035638
	Price	N/A -	N/A -	N/A -

TIPS
MICROPIPETTES

Eppendorf Reference® 2 Micropipettes

Very high precision, robust and original design with a single control button for pipetting and ejection.

- **Single button operation:** notch at end of pipetting for tip ejection
- **No lateral movement of the thumb**
- **Tip-holder end with shock absorber**
- **Integrated RFID chip** provides simple identification and documentation
- **Supplied with EN ISO 8655 certificate of conformity, a box of epTIPS tips (only with variable volume pipettes) and an adapter for Eppendorf universal carousel (only with multichannel pipettes)**
- **Warranty: 3 years**
- **2 versions:**
- **GLP (General Lab Product), for all applications other than human diagnosis**
- **CE/IVD, for human clinical applications (human diagnosis)**



Eppendorf Reference® 2 Micropipettes - variable volume

Volume (µl)	Colour push button	Reference® 2 GLP		Reference® 2 CE/IVD	
		Cat. No.	Price	Cat. No.	Price
0.1 - 2.5	Anthracite	933984	N/A -	033017B	N/A -
0.5 - 10	Grey	933985	N/A -	033018B	N/A -
2 - 20	Light grey	933986	N/A -	033019B	N/A -
2 - 20	Yellow	933987	N/A -	033020B	N/A -
10 - 100	Yellow	933988	N/A -	033021B	N/A -
20 - 200	Yellow	933989	N/A -	033022B	N/A -
30 - 300	Orange	933990	N/A -	933041	N/A -
100 - 1000	Blue	933991	N/A -	033023B	N/A -
250 - 2500	Red	933992	N/A -	033024B	N/A -
500 - 5000	Violet	933993	N/A -	933042	N/A -
1000 - 10000	Turquoise	933994	N/A -	933043	N/A -

Eppendorf Reference® 2 multichannel Micropipettes

Volume (µl)	Code Colour	8-channel				12-channel			
		Reference® 2 GLP		Reference® 2 CE/IVD		Reference® 2 GLP		Reference® 2 CE/IVD	
		Cat. No.	Price	Cat. No.	Price	Cat. No.	Price	Cat. No.	Price
0.5 - 10	Grey	934015	N/A -	933031	N/A -	934016	N/A -	933032	N/A -
10 - 100	Yellow	934017	N/A -	933033	N/A -	934018	N/A -	933034	N/A -
30 - 300	Orange	934019	N/A -	933035	N/A -	934020	N/A -	933036	N/A -



Eppendorf racks: See page 488

Reference® 2 Micropipettes Pack



		Pack 1: 3 micropipettes Reference® 2 with ep T.I.P.S.	Pack 2: 3 micropipettes Reference® 2 with ep T.I.P.S.	Pack 3: 3 micropipettes Reference® 2 with ep T.I.P.S.
Reference® 2 GLP	Cat. No.	933995	933996	933997
Reference® 2 GLP	Price	N/A -	N/A -	N/A -
Reference® 2 CE/IVD	Cat. No.	033504B	033505B	933069
Reference® 2 CE/IVD	Price	N/A -	N/A -	N/A -

TIPS MICROPIPETTES

Xplorer® and Xplorer® plus Electronic micropipettes



Eppendorf racks: see page 488



- ▶ Light and balanced
- ▶ Tip-holder end with shock absorber
- ▶ Intuitive operation
- ▶ Pipetting mode selection wheel
- ▶ Adjustable parameters on 1 screen
- ▶ French texts with help function
- ▶ Large backlit display, easy to read in any position
- ▶ User adjustment and predefined adjustments (e.g. to different types of liquids)
- ▶ Lithium-Polymer battery with long autonomy (3000 pipettings), possibility to work while recharging
- ▶ Same charger (and charger holder) as for the Multipette Stream/Xstream
- ▶ Integrated RFID chip provides simple identification and documentation
- ▶ Supplied with charging adapter and calibration certificate according to EN ISO 8655

Two versions

- ▶ **Xplorer®**: comfort and repeatability for common liquid dispensing applications
- ▶ **Xplorer® plus**: allows all the most sophisticated liquid dispensing applications to be carried out and also allows a complete process to be programmed; has an internal clock with reminders for service and metrological checks

Mode	Applications	Xplorer®	Xplorer® plus
Ads	Automatic dispensing	•	•
Dis	Dispensing	•	•
Pip	Pipetting	•	•
P/M	Pipetting and Mixing	•	•
Man	Manual pipetting	•	•
Opt	Option	•	•
Spc	Special applications:		
	Multi-suction		•
	Dilution		•
	Sequential distribution		•
	Reverse pipetting		•
Prg	Sequential pipetting		•
	Programme of application sequences		•
Edit	Editing/modifying programmes and fixed volumes		•
Fix	Fixed Pre-recorded and editable volumes		•



Eppendorf Xplorer® and Xplorer® plus monocal Micropipettes - including charger

Volume (µl)	Colour push button	Xplorer®		Xplorer® plus	
		Cat. No.	Price	Cat. No.	Price
0.5 - 10	Grey	035639	N/A -	035813	N/A -
1 - 20	Light grey	934305	N/A -	934308	N/A -
5 - 100	Yellow	035640	N/A -	035814	N/A -
10 - 200	Yellow	934306	N/A -	934309	N/A -
15 - 300	Orange	035641	N/A -	035815	N/A -
50 - 1000	Blue	035642	N/A -	035816	N/A -
250 - 2500	Red	934307	N/A -	934310	N/A -
500 - 5000	Violet	035643	N/A -	035817	N/A -
1000 - 10000	Turquoise	035644	N/A -	035818	N/A -

Eppendorf Xplorer® and Xplorer® plus multichannel Micropipettes - including charger

Volume	Colour push button	Xplorer®				Xplorer® plus			
		8-channel		12-channel		8-channel		12-channel	
		Cat. No.	Price	Cat. No.	Price	Cat. No.	Price	Cat. No.	Price
0.5 - 10 µl	Grey	035645	927.N/A -	035646	N/A -	035819	N/A -	035821	N/A -
5 - 100 µl	Yellow	035647	927.N/A -	035648	N/A -	035822	N/A -	035823	N/A -
15 - 300 µl	Orange	035649	927.N/A -	035650	N/A -	035824	N/A -	035825	N/A -
50 - 1200 µl	Green	035651	927.N/A -	035812	N/A -	035826	N/A -	035827	N/A -

Pipette filter

For pipette volume of	5 ml			10 ml		
	Cat. No.	Units/bag	Price	Cat. No.	Units/bag	Price
Micropipettes Research plus, Reference, Reference 2, Xplorer	933162	10	N/A -	933163	10	N/A -

Eppendorf Xplorer® plus Micropipettes 16 and 24 channel



Volume (µl)	Code Colour	16-channel		24-channel	
		Xplorer® plus GLP	Price	Xplorer® plus GLP	Price
1 - 20	Light pink	934331	N/A -	934332	N/A -
5 - 100	Light yellow	934333	N/A -	934334	N/A -

- ▶ Simplifies filling of 384-well microplates
- ▶ 4.5 mm spacing between the tips

- ▶ SOFTattach technology for better tip fixation
- ▶ SOFTject system for successive tip ejection, reducing ejection forces
- ▶ Only compatible with ep.T.I.P.S. tips. 384

TIPS
MICROPIPETTES

Move It® multichannel micropipettes with variable spacing

- Multichannel pipettes with adjustable tip spacing available in mechanical (Research plus) and electronic (Xplorer plus) versions
- Quick and easy changeover of different plate formats thanks to predefined parameters
- Suitable for use with plates (384, 96, 48, 24 and 12 wells), tubes (1.5 and 2 ml) and agarose gels
- Adjustable tip spacing between 4.5 and 33 mm, depending on the pipette model
- Optimised ergonomics and balance to reduce muscle fatigue
- 360° rotating pipette head for comfortable display readability and quick parameter identification
- Easily autoclavable:
 - Research plus: fully autoclavable
 - Xplorer plus: Lower part only
- Tubeless system for reliability and safety



		Research plus							
		4-channel		6-channel		8-channel		12-channel	
Volume (µl)	Colour code	Cat. No.	Price	Cat. No.	Price	Cat. No.	Price	Cat. No.	Price
30 - 300	Orange	934498	N/A-	934499	N/A-	934500	N/A-	-	-
120 - 1200	Dark green	934501	N/A-	934502	N/A-	934503	N/A-	-	-

		Xplorer plus							
		4-channel		6-channel		8-channel		12-channel	
Volume (µl)	Colour code	Cat. No.	Price	Cat. No.	Price	Cat. No.	Price	Cat.No	Price
1 - 20	Pink	-	-	-	-	934504	N/A-	934505	N/A-
5 - 100	Yellow	-	-	-	-	934506	N/A-	934507	N/A-
15 - 300	Orange	934508	N/A-	934509	N/A-	934510	N/A-	-	-
50 - 1200	Green	934511	N/A-	934512	N/A-	934513	N/A-	-	-

epT.I.P.S. tips Eppendorf

- Fine gradations
- 2 versions*
- - CE/IVD, for human clinical applications (human diagnostic)
- GLP (General Lab Product), for non-human diagnostic applications
- * standard bulk tips are not marked



epT.I.P.S. ... Eppendorf Totally Integrated Pipetting System.

A wide range of presentations: in bulk, in refillable racks (epT.I.P.S. reloads), epT.I.P.S. box, epT.I.P.S. set, BIOPUR sterile, in individual blister packs, with filter.

- Bulk In resealable bags
- EpT.I.P.S.Reloads: a set of 10 reload trays that can be placed in the epT.I.P.S. Box.
- EpT.I.P.S. Box: refillable and reusable box, hinged lid; accepts trays of epT.I.P.S. refill tips Reloads.
- EpT.I.P.S. Set: refillable and reusable box, hinged lid with 5 tip trays
- EpT.I.P.S. Racks Certified PCR clean, sterile, non-pyrogenic, ATP-free and DNA-free
- Individually packaged: certified PCR clean, sterile, non-pyrogenic, ATP-free and DNA-free
- epT.I.P.S. 384: for 16 and 24 channel micropipettes



TIPS
MICROPIPETTES

EpT.I.P.S. tips Eppendorf

	Volume (µl)	Long. (mm)	Colour		Standard					PCR clean		Biopur (sterile)	
					Bulk	epT.I.P.S. Reloads	epT.I.P.S. Box**	epT.I.P.S. Set*	epT.I.P.S. Rack	epT.I.P.S. Reloads	epT.I.P.S. Rack	Individual packaging	epT.I.P.S. Rack
	0.1 - 10	34	Dark grey	Cat. No. IVD	-	033671	033654	033663	-	033679	-	-	-
				Cat. No. GLP	-	934247	934230	934239	-	934258	-	-	-
				Cat. No. without marking	033642	-	-	-	-	-	-	-	-
				Units/box	2 x 500	10 x 96	96	5 x 96	-	10 x 96	-	-	-
				Price/box	N/A -	N/A -	N/A -	N/A -	-	N/A -	-	-	-
	0.1 - 20	40	Medium grey	Cat. No. IVD	-	033672	033655	033664	-	033680	-	033651	033687B
				Cat. No. GLP	-	934248	934231	934240	-	934259	-	934227	934266B
				Cat. No. without marking	033643	-	-	-	-	-	-	-	
				Units/box	2 x 500	10 x 96	96	5 x 96	-	10 x 96	-	100	5 x 96
				Price/box	N/A -	N/A -	N/A -	N/A -	-	N/A -	-	N/A -	N/A -
	0.5-20 L	46	Light grey	Cat. No. IVD	-	033673	033656	033665	-	033681	-	-	-
				Cat. No. GLP	-	934249	934232	934241	-	934260	-	-	-
				Cat. No. without marking	033644	-	-	-	-	-	-	-	
				Units/box	2 x 500	10 x 96	96	5 x 96	-	10 x 96	-	-	-
				Price/box	N/A -	N/A -	N/A -	N/A -	-	N/A -	-	-	-
	2-200	53	Yellow	Cat. No. IVD	-	033674	033657	033666	-	033682	-	033652	033688B
				Cat. No. GLP	-	934250	934233	934242	-	934261	-	934228	934267B
				Cat. No. without marking	033645	-	-	-	-	-	-	-	
				Units/box	2 x 500	10 x 96	96	5 x 96	-	10 x 96	-	100	5 x 96
				Price/box	N/A -	N/A -	N/A -	N/A -	-	N/A -	-	N/A -	N/A -
	20-300	55	Orange	Cat. No. IVD	-	033675	033658	033667	-	033683	-	-	033689B
				Cat. No. GLP	-	934251	934234	934243	-	934262	-	-	934268B
				Cat. No. without marking	033646	-	-	-	-	-	-	-	
				Units/box	2 x 500	10 x 96	96	5 x 96	-	10 x 96	-	-	5 x 96
				Price/box	N/A -	N/A -	N/A -	N/A -	-	N/A -	-	-	N/A -
	50-1000	71	Blue	Cat. No. IVD	-	033676	033659	033668	-	033684	-	033653	033690B
				Cat. No. GLP	-	934252	934235	934244	-	934263	-	934229	934269B
				Cat. No. without marking	033647	-	-	-	-	-	-	-	
				Units/box	2 x 500	10 x 96	96	5 x 96	-	10 x 96	-	100	5 x 96
				Price/box	N/A -	N/A -	N/A -	N/A -	-	N/A -	-	N/A -	N/A -
	50-1250	76	Green	Cat. No. IVD	-	033677	033660	033669	-	033685	-	-	033691B
				Cat. No. GLP	-	934253	934236	934245	-	934264	-	-	934270B
				Cat. No. without marking	033648	-	-	-	-	-	-	-	
				Units/box	2 x 500	10 x 96	96	5 x 96	-	10 x 96	-	-	5 x 96
				Price/box	N/A -	N/A -	N/A -	N/A -	-	N/A -	-	-	N/A -
	50-1250 L	103	Dark green	Cat. No. IVD	-	035655	035657	-	035656	-	-	035658B	
				Cat. No. GLP	-	934255	934257	-	934256	-	-	934273B	
				Cat. No. without marking	035654	-	-	-	-	-	-	-	
				Units/box	2 x 500	10 x 96	96	-	10 x 96	-	-	5 x 96	
				Price/box	N/A -	N/A -	N/A -	-	N/A -	-	-	N/A -	
	500-2500	115	Red	Cat. No. IVD	-	033678	033661	033670	-	033686	-	-	033692B
				Cat. No. GLP	-	934254	934237	934246	-	934265	-	-	934271B
				Cat. No. without marking	033649	-	-	-	-	-	-	-	
				Units/box	5 x 100	10 x 48	48	5 x 48	-	10 x 48	-	-	5 x 48
				Price/box	N/A -	N/A -	N/A -	N/A -	-	N/A -	-	-	N/A -
	100-5000	120	Violet	Cat. No. IVD	033650	-	033662	-	-	-	-	-	933183B
				Cat. No. GLP	-	-	934238	-	934478	-	934481	-	934274B
				Cat. No. without marking	033650	-	-	-	-	-	-	-	
				Units/box	5 x 100	-	24	-	5 x 24	-	5 x 24	-	5 x 24
				Price/box	N/A -	-	N/A -	-	N/A -	-	N/A -	-	N/A -
	200-5000	175	Violet	Cat. No. IVD	-	-	-	-	-	-	-	-	033329B
				Cat. No. GLP	-	-	-	-	934479	-	-	-	934272B
				Cat. No. without marking	033327	-	-	-	-	-	-	-	
				Units/box	2 x 100	-	-	-	5 x 24	-	-	-	5 x 24
				Price/box	N/A -	-	-	-	N/A -	-	-	-	N/A -
	500 - 10000	165	Turquoise	Cat. No. IVD	-	-	-	-	-	-	-	-	933236B
				Cat. No. GLP	-	-	-	-	934480	-	-	-	934275B
				Cat. No. without marking	933217	-	-	-	-	-	-	-	
				Units/box	3 x 100	-	-	-	5 x 24	-	-	-	5 x 24
				Price/box	N/A -	-	-	-	N/A -	-	-	-	N/A -
	500-10000 L	243	Turquoise	Cat. No. without marking	033328	-	-	-	-	-	-	-	
				Units/box	2 x 100	-	-	-	-	-	-	-	
				Price/box	N/A -	-	-	-	-	-	-	-	



Tips not shown to scale. Refer to the lengths (in mm) in the table
 * 1 epT.I.P.S. box + 5 epT.I.P.S. refills ** Boxes loaded with tips

TIPS
MICROPIPETTES

ep Dualfilter T.I.P.S. and ep Dualfilter T.I.P.S. SealMax Eppendorf

- Double protection with double filter (for both pipette and sample)
- Retains aerosols and biomolecules
- **LoRetention version:** with ultra-smooth surface to allow perfect flow of even the stickiest liquids such as PCR Mix
- **SealMax version:** biomolecules and a reliable barrier against liquids
- **Forensic DNA version:** ISO 18385 certified, free of human DNA, DNase, RNase and PCR inhibitor
- Unique manufacturing process without release agents, plasticizers or biocides. The integrity of the samples is guaranteed
- No additives or PCR inhibitors
- Eppendorf PCR clean quality, sterile and pyrogen free
- Batch certification

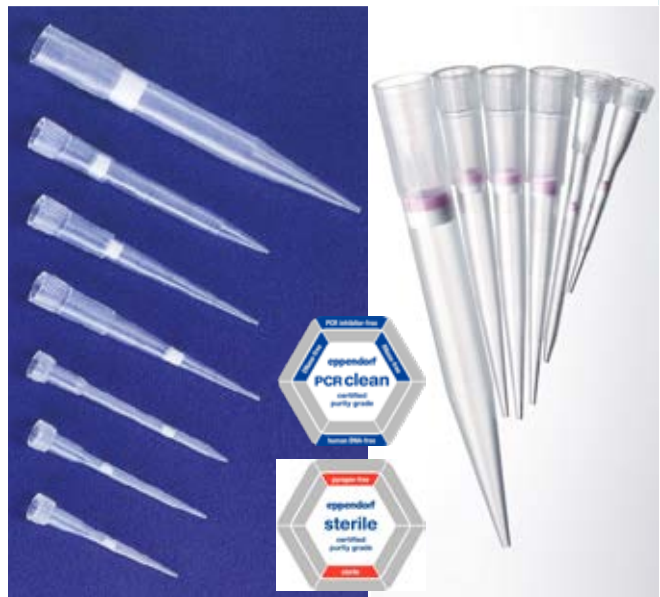

DNase
RNase



Volume (µl)	0.1 - 10	0.1 - 10	0.5 - 20	2 - 20	2 - 100	2 - 200	20 - 300	50 - 1000	50 - 1250	250 - 2500	100 - 5000	200 - 5000	500 - 10000
Length (mm)	34	40	46	53	53	55	55	76	103	115	120	175	243
Colour	Dark grey	Medium grey	Light grey	Yellow	Yellow	Yellow	Orange	Blue	Dark green	Red	Violet	Violet	Turquoise
Units/box	10 x 96	10 x 96	10 x 96	10 x 96	10 x 96	10 x 96	10 x 96	10 x 96	5 x 96	5 x 48	5 x 24	5 x 24	100
Standard	033693B	033694B	033695B	033699B	033696B	033910B	033697B	033698B	035659B	934482	033907B	933237B	033330
Price/box	N/A -	N/A -	N/A -	N/A -	N/A -	N/A -	N/A -	N/A -	N/A -	N/A -	N/A -	N/A -	N/A -
Lo-Retention	-	035097B	-	035098B*	035099B	-	035345B	035346B	-	-	-	-	-
Price/box	-	N/A -	-	N/A -	N/A -	-	N/A -	N/A -	-	-	-	-	-
SealMax	933103B	-	933104B	-	933105B	933106B	933107B	933099B	-	-	-	-	-
Price/box	N/A -	-	N/A -	-	N/A -	N/A -	N/A -	N/A -	-	-	-	-	-
Forensic DNA	-	933923B	-	933924B	-	933925B	-	933926B	-	-	-	-	-
Price/box	-	N/A -	-	N/A -	-	N/A -	-	N/A -	-	-	-	-	-

* Volume: 0.5 - 20 µl

EpT.I.P.S. tips Eppendorf LoRetention

- Ultra-homogeneous surface for maximum reproducibility
- Minimal sample loss due to ultra-hydrophobic surface
- Significantly reduced foam formation during pipetting
- Autoclavable and chemical resistant
- epT.I.P.S. Reloads: a set of 10 trays that can be placed in the epT.I.P.S. Box (see page 486)

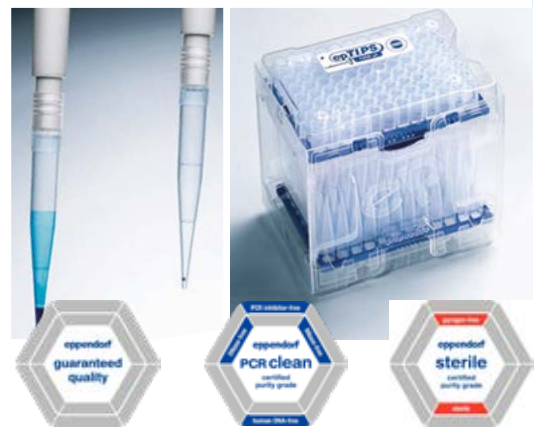

Volume (µl)	Units/box*	epT.I.P.S. Reloads		epT.I.P.S. Set**		epT.I.P.S. Reloads PCR Clean		epT.I.P.S. with filter Dualfilter PCR Clean sterile	
		Cat. No.	Price/box	Cat. No.	Price/box	Cat. No.	Price/box	Cat. No.	Price/box
0.1 - 10 S	10 x 96	035093	N/A -	035714	N/A -	035088	N/A -	035097B	N/A -
0.5 - 20 L	10 x 96	035094	N/A -	035715	N/A -	035089	N/A -	035098B	N/A -
2 - 100	10 x 96	-	-	-	-	-	-	035099B	N/A -
2 - 200	10 x 96	035095	N/A -	035716	N/A -	035091	N/A -	-	-
20 - 300	10 x 96	-	-	-	-	-	-	035345B	N/A -
50 - 1000	10 x 96	035096	N/A -	035717	N/A -	035092	N/A -	035346B	N/A -
50 - 1250	480	-	-	-	-	-	-	035659B	N/A -

* 10 x 96 tip boxes ** = 1 epT.I.P.S. Box + 5 epT.I.P.S. refill Reloads (5 x 96)

EpT.I.P.S. tips 384 and epT.I.P.S. Dualfilter 384

Volume (µl)	Long. (mm)	Colour code	Units/box	EpT.I.P.S. 384			EpT.I.P.S. Dualfilter 384	
				Standard		PCR clean	PCR clean/sterile	
				epT.I.P.S. Reloads	epT.I.P.S. Set	Box	epT.I.P.S. Reloads	EpT.I.P.S. Rack
0.1 - 20	42	Light pink	Cat. No. GLP	934315	934313	-	934311	934321B
			Price/box	N/A -	N/A -	-	N/A -	N/A -
			Cat. No. CE/IVD	-	-	934319	934317	-
0.5 - 100	53	Light yellow	Cat. No. GLP	934316	934314	-	934312	934322B
			Price/box	N/A -	N/A -	-	N/A -	N/A -
			Cat. No. CE/IVD	-	-	934320	934318	-
			Price/box	-	-	N/A -	N/A -	-

Eppendorf TrackIT



- RFID chip reading of Eppendorf micropipettes
- Centralized storage of essential information, such as calibration data for each micropipette

Cat. No.	Description	Price
933039	Eppendorf TrackIT, software and RFID reader	N/A -

Eppendorf pipette carousels, charger holders and wall-mounting devices



- The manual micropipette carousel holder is compatible with all existing Eppendorf pipettes and most pipettes from previous ranges
- The carousel charger rack holds up to six electronic devices thanks to the magnetic connector that allows for quick and easy connection
- Micropipette holders can be mounted on the wall or on carousel racks (no tools required, wall mounting tape included)

Racks

Cat. No.	Description	Price
933908	Carousel rack for 6 single or multi channel manual pipettes	N/A -
933909	Charging carousel rack for 6 pipettes Xplorer® / Xplorer® plus, with power adapter	N/A -
933910	Charging rack for 1 pipette Xplorer® / Xplorer® plus, without power adapter*	N/A -
933911	Charging rack for 1 pipette Multipipette® E3/E3x or Stream/Xstream, without power adapter*	N/A -
933912	Rack for 1 pipette Multipipette® M4 without loading functionality	N/A -

Stands

Cat. No.	Description	Price
933913	Holder for 1 pipette Research®, Research® plus, Reference®, Reference® 2 or Biomaster	N/A -
933914	Holder for 1 pipette Xplorer® or Xplorer® plus	N/A -
933915	Holder for 1 pipette Multipipette® E3/E3x or Multipipette® Stream/Xstream	N/A -
933916	Holder for 1 pipette Multipipette® M4	N/A -
933917	Charging stand for 1 pipette Xplorer® or Xplorer® plus	N/A -
933918	Charging stand for 1 pipette Multipipette® E3/E3x or Multipipette® Stream/Xstream	N/A -

* For use with the charger supplied with the pipettes.

Thermoscientific micropipettes

Model	F1-ClipTip	E1 Clip-Tip	E1 Clip-Tip Equalizer	Finnpipette F1	Finnpipette F2	Finnpipette F3	Novus
Operating mode	Manual	Electronic	Electronic	Manual	Manual	Manual	Electronic
Adjustable spacing between tips	No	No	Yes	No	No	No	No
Highlights	Clip Tip technology, lightweight, rotating finger rest	ClipTip technology, motorized ejection, index control, 30 recordable pipetting protocols		Lightweight, adjustable finger rest, power ejector, volume lock	Lightweight, low tip attachment force, power ejector, UV resistant		Balanced handling, 10 functions and 9 pipetting speeds, programmable
Volume range	0.1 µl - 1 ml	0.5 µl - 1.25 ml		0.2 - 10 ml			0.1 µl - 10 ml
Available options	1 channel, 8 channel, 12 channel	1 channel, 8 channel, 12 channel, 16 channel	6, 8 and 12 channel	1 channel, 8 channel, 12 channel, 16 channel	1 channel, 8 channel, 12 channel, 16 channel	1-channel	1 channel, 8 channel, 12 channel, 16 channel
Autoclavable parts	Lower part and ejector	Lower part and ejector	Entirely	Lower part and ejector	Entirely	Lower part and ejector	Lower part

Finnpipettes F1-ClipTip and E1-ClipTip

➤ ClipTip technology

- Locking tip system with snap-on flange assembly and full seal
- Ensures greater safety: no risk of the tip coming loose or falling out
- Requires very low tip attachment and ejection force
- ClipTip micropipettes can only be used with ClipTip tips

➤ Finnpipette F1-ClipTip

- Lightweight and ergonomically optimised with rotating finger rest
- Lockable volume adjustment



F1-ClipTip

Kit 1 F1-ClipTip GLP

F1-ClipTip Pipettes, single-channel, variable volume

Volume (µl)	Increment (µl)	Suitable tips	Cat. No.	Price
0.1 - 2	0.002	ClipTip 12.5 ext.	228846	N/A -
1 - 10	0.02	ClipTip 12.5 ext.	228842	N/A -
2 - 20	0.02	ClipTip 20	228386N	N/A -
5 - 50	0.1	ClipTip 50	228387N	N/A -
10 - 100	0.2	ClipTip 200	228388N	N/A -
20 - 200	0.2	ClipTip 200	228389N	N/A -
30 - 300	1	ClipTip 300	228390N	N/A -
100 - 1000	1	ClipTip 1000	228391N	N/A -

F1-ClipTip multichannel variable volume pipettes

Volume (µl)	Increment (µl)	Suitable tips	8-channel		12-channel	
			Cat. No.	Price	Cat. No.	Price
1 - 10	0.02	ClipTip 12.5 ext.	228844	N/A -	228845	N/A -
5 - 50	0.1	ClipTip 50	228404N	N/A -	228408N	N/A -
10 - 100	0.2	ClipTip 200	228405N	N/A -	228409N	N/A -
30 - 300	1	ClipTip 300	228406N	N/A -	228410N	N/A -

F1-ClipTip GLP Kits

Cat. No.	Description	Price
228411N	Kit 1 F1-ClipTip GLP • F1-ClipTip: 1 - 10 µl single channel, 10-100 µl single channel, 100 - 1000 µl single channel • F-Series Rack • ClipTip: 1 rack, 1 rack 200 µl, 1 rack 1000 µl • 25 ml tank, 25 ml split tank, 100 ml split tank	N/A -
228412N	Kit 2 F1-ClipTip GLP • F1-ClipTip: 2 - 20 µl single channel, 20 - 200 µl single channel, 100 - 1000 µl single channel, 30 - 300 µl 8 channel • F-Series Rack • ClipTip: 20 µl rack, 200 µl rack, 1000 µl rack • 25 ml tank, 25 ml split tank, 100 ml split tank	N/A -

Finnpipettes F1-ClipTip and E1-ClipTip (continued)



▶ Electronic Finnpipettes E1 ClipTip

- ▶ Intuitive and ergonomic with motorised ejection and index finger control of the pipette
- ▶ Bluetooth or USB connection to a computer to create and share programs between E1 pipettes
- ▶ Up to 30 pipetting protocols can be stored
- ▶ Loading time of only 2 hours

E1-ClipTip Pipettes, single-channel variable volume

Volume (µl)	Increment (µl)	Suitable tips	Cat. No.	Price
0.5 - 12.5	0.01	ClipTip 12.5	228571BT	N/A -
2 - 125	0.1	ClipTip 200	228572BT	N/A -
10 - 300	0.1	ClipTip 300	228573BT	N/A -
15 - 1250	1	ClipTip 1250	228574BT	N/A -

E1-ClipTip multichannel variable volume pipettes

Volume (µl)	Increment (µl)	Suitable tips	8-channel		12-channel		16-channel*	
			Cat. No.	Price	Cat. No.	Price	Cat. No.	Price
0.5 - 12.5	0.01	ClipTip 12.5	228575BT	N/A -	228579BT	N/A -	228583BT	N/A -
1 - 30	0.01	ClipTip 30	-	-	-	-	228584BT	N/A -
2 - 125	0.1	ClipTip 200	228576BT	N/A -	228580BT	N/A -	228585BT	N/A -
10 - 300	0.1	ClipTip 300	228577BT	N/A -	228581BT	N/A -	-	-
30 - 850	1	ClipTip 1000	-	-	228582BT	N/A -	-	-
15 - 1250	1	ClipTip 1250	228578BT	N/A -	-	-	-	-

* Only compatible with the corresponding Cliptip 384 racks.



E1-ClipTip Equalizer Pipettes

Pipettes with adjustable volume and space between the tips.

Volume (µl)	Increment (µl)	Suitable tips	6-channel		8-channel	
			Cat. No.	Price	Cat. No.	Price
2 - 125	0.1	ClipTip 200	-	-	228587BT	N/A -
10 - 300	0.1	ClipTip 300	-	-	228588BT	N/A -
15 - 1250	1	ClipTip 1250	228586BT	N/A -	228589BT	N/A -

E1-ClipTip Equalizer 384 Pipettes

Pipettes with adjustable volume and tip spacing, suitable for 384-well plates. Use only with ClipTip 384 tips.

Volume (µl)	Increment (µl)	Suitable tips	8-channel		12-channel	
			Cat. No.	Price	Cat. No.	Price
0.5 - 12.5	0.01	ClipTip 12.5	228590BT	N/A -	228593BT	N/A -
1 - 30	0.01	ClipTip 30	228591BT	N/A -	228594BT	N/A -
2 - 125	0.1	ClipTip 200	228592BT	N/A -	228595BT	N/A -



ClipTip Tips

Type	Length (mm)	Step Size (mm)	Ø int. (mm)
ClipTip 12.5	30	9	0.4
ClipTip 20	46	17	0.4
ClipTip 50	51	17	0.4
ClipTip 200	56	22	0.5
ClipTip 300	63	22	0.6
ClipTip 1000	95	32	1.1
ClipTip 1250	103	32	0.9
ClipTip 384 - 12.5	30	9	0.4
ClipTip 384 - 30	44	9	0.4
ClipTip 384 - 125	64	9	0.5

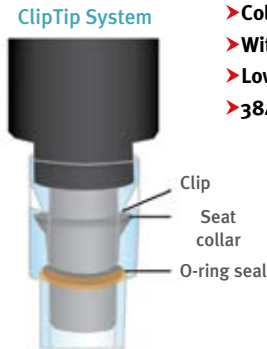

- > Colour coding of tip trays and marking of batch and volumes
- > With or without filter (14 µm pore super-filters)
- > Low retention Tips
- > 384 tips are specially adapted to the E1-ClipTip Equalizer 384 pipette

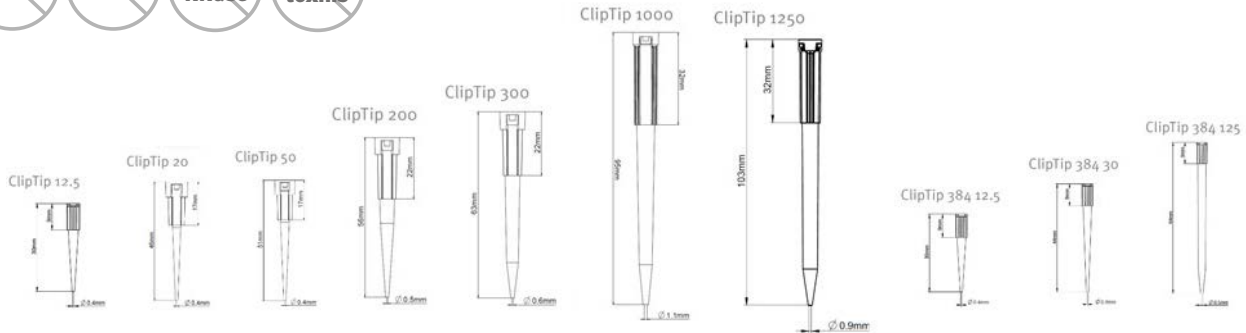

Type	Vol. Range (µl)	Colour code	In a rack			In sterile rack			In refill			In sterile refill			In sterile rack with filter			In sterile refill with filter		
			Cat. No.	Units/box	Price/box	Cat. No.	Units/box	Price/box	Cat. No.	Units/box	Price/box	Cat. No.	Units/box	Price/box	Cat. No.	Units/box	Price/box	Cat. No.	Units/box	Price/box
ClipTip 12.5	0.5-12.5	Pink	228606	10 x 96	N/A	228607	10 x 96	N/A	-	-	-	-	-	-	228608	10 x 96	N/A	-	-	-
ClipTip 12.5 ext.	01-12.5	Pink	228847	10 x 96	N/A	228848	10 x 96	N/A	-	-	-	-	-	-	228849	10 x 96	N/A	-	-	-
ClipTip 20	1-20	Pink	228352	10 x 96	N/A	228353	10 x 96	N/A	228354	10 x 96	N/A	228355	10 x 96	N/A	228356	10 x 96	N/A	228357	10 x 96	N/A
ClipTip 50	5-50	Violet	228358	10 x 96	N/A	228359	10 x 96	N/A	228360	10 x 96	N/A	228361	10 x 96	N/A	228362	10 x 96	N/A	-	-	-
ClipTip 200	2-200	Yellow	228364	10 x 96	N/A	228365	10 x 96	N/A	228366	10 x 96	N/A	228367	10 x 96	N/A	228368	10 x 96	N/A	228369	10 x 96	N/A
ClipTip 300	10-300	Orange	228370	10 x 96	N/A	228371	10 x 96	N/A	228372	10 x 96	N/A	228373	10 x 96	N/A	228374	10 x 96	N/A	228375	10 x 96	N/A
ClipTip 300 ext. Low retention	10-300	Orange	228853	10 x 96	N/A	228854	10 x 96	N/A	228855	10 x 96	N/A	228857	10 x 96	N/A	228856	10 x 96	N/A	-	-	-
ClipTip 1000	30-1000	Blue	228376	10 x 96	N/A	228377	10 x 96	N/A	228378	10 x 96	N/A	228379	10 x 96	N/A	228380	8 x 96	N/A	228381	10 x 96	N/A
ClipTip 1250	50-1250	Turquoise	228609	8 x 96	N/A	228610	8 x 96	N/A	228611	8 x 96	N/A	228612	8 x 96	N/A	228613	8 x 96	N/A	228614	8 x 96	N/A
ClipTip 384 - 12.5	0.5-12.5	Pink	228597	10 x 384	N/A	228598	10 x 384	N/A	-	-	-	-	-	-	228599	10 x 384	N/A	-	-	-
ClipTip 384 - 12.5 ext.	0.5-12.5	Pink	228850	10 x 384	N/A	228851	10 x 384	N/A	-	-	-	-	-	-	228852	10 x 384	N/A	-	-	-
ClipTip 384 - 30	1-30	Violet	228600	10 x 384	N/A	228601	10 x 384	N/A	-	-	-	-	-	-	228602	10 x 384	N/A	-	-	-
ClipTip 384 - 125	2-125	Yellow	228603	10 x 384	N/A	228604	10 x 384	N/A	-	-	-	-	-	-	228605	10 x 384	N/A	-	-	-

Empty racks

Cat. No.	Type	Colour		Price 10 units
228382	Small	Pink	Violet	N/A
228383	Medium	Yellow	Orange	N/A
228858	-	Orange		N/A
228384	Big	Blue		N/A

TIPS MICROPIPETTES

Finnpipettes F1, F2 and F3

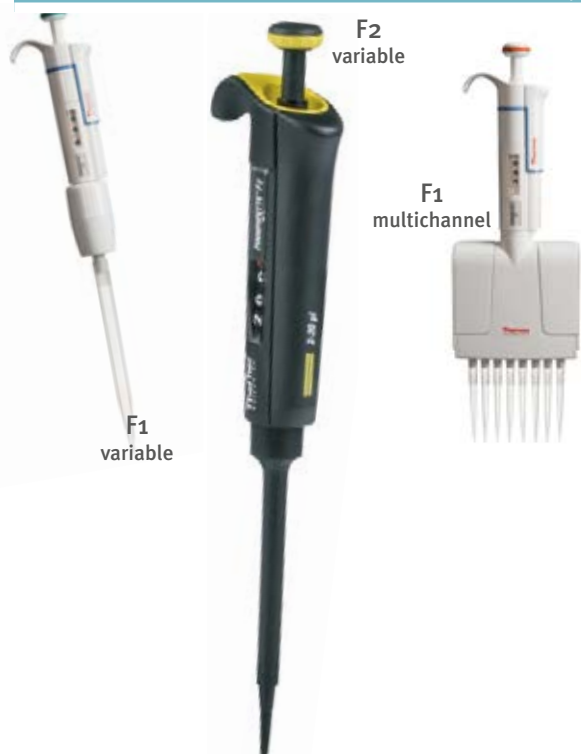

Common features

- ▶ Lightweight handle, little force required for attachment, tip ejection and pipetting
- ▶ Patented "Super Blow-out" system: an additional volume of air is blown in to increase the accuracy of microvolumes up to 50 µl
- ▶ "Ergovision" display: Black number on white background for better readability
- ▶ Each pipette is delivered with: a calibration certificate, a removal/calibration key, an adhesive holder
- ▶ Also available in fixed volume, find them on our website
- ▶ Warranty: 3 years

Features Finn pipette F1

- ▶ Finger rest can be adjusted to 120 °C to suit left and right handed users
- ▶ Power-assisted ejector: reduces tip ejection pressure by 50% and limits liquid splashing
- ▶ Lockable volume adjustment
- ▶ Autoclavable lower part

Features Finn pipette F2

- ▶ Resistant to UV Materials
- ▶ Fully autoclavable without disassembly
- ▶ Power-assisted ejector: reduces tip ejection pressure by 50% and limits liquid splashing
- ▶ Double-action push button to prevent accidental volume changes during operation

Features Finn pipette F3

- ▶ Resistant to UV Materials
- ▶ Autoclavable lower part
- ▶ Double-action push button to prevent accidental volume changes during operation

Finnpipettes F1 F2 and F3, single channel, variable volume

Volume (µl)	Increment (µl)	Suitable tips	Finnpipettes F1		Finnpipettes F2		Finnpipettes F3	
			Cat. No.	Price	Cat. No.	Price	Cat. No.	Price
0.2 - 2	0.002	Flex 10, 10, 50 micro	050635N	N/A -	050600	N/A -	-	-
0.5 - 5	0.01	Flex 10, 10, 50 micro	050636N	N/A -	050601	N/A -	-	-
1 - 10 (micro)	0.02	Flex 10, 10, 50 micro	050637N	N/A -	050602	N/A -	050673	N/A -
1 - 10	0.02	Flex 200, 250 Univ.	050638N	N/A -	050603	N/A -	050674	N/A -
2 - 20 (micro)	0.02	50 micro	050639N	N/A -	050604	N/A -	050675	N/A -
2 - 20	0.02	Flex 200, 250 Univ.	050640N	N/A -	050605	N/A -	050676	N/A -
5 - 50 (micro)	0.02	50	050692N	N/A -	050694	N/A -	050690	N/A -
5 - 50	0.02	Flex 200, 250 Univ., 300, 200 length	050693N	N/A -	050695	N/A -	050691	N/A -
10 - 100	0.2	Flex 200, 250 Univ., 300, 200 length	050641N	N/A -	050606	N/A -	050677	N/A -
20 - 200	0.2	Flex 200, 250 Univ., 300, 200 length	050642N	N/A -	050607	N/A -	050678	N/A -
30 - 300	1	Flex 300, 300	050643N	N/A -	-	-	-	-
100 - 1000	1	Flex 1000, 1000, 1000 length	050644N	N/A -	050608	N/A -	050679	N/A -
500 - 5000	10	5 ml	050645N	N/A -	050609	N/A -	050697	N/A -
1000 - 10000	20	10 ml	050646N	N/A -	050610	N/A -	050680	N/A -

Finnpipettes F1, F2 and F3 Packs

	GLP-Kit-1	GLP-Kit-2	GLP-Kit-3	GLP-Kit-4	Starter Pack
Includes: Finnpipettes (models shown): + F-Stand + Finntips + tanks	1 - 10 µl micro 10 - 100 µl standard 100 - 1000 µl	0.2 - 2 µl 2 - 20 µl standard 20 - 200 µl 100 - 1000 µl	10 - 100 µl 100 - 1000 µl 1 - 10 ml	2 - 20 µl standard 20 - 200 µl 100 - 1000 µl	2 - 20 µl standard 20 - 200 µl 100 - 1000 µl 1 - 10 ml
Finnpipette F1 Pack	4700850N	4700860N	4700865N	4701060N	-
Price	N/A -	N/A -	N/A -	N/A -	-
Finnpipette F2 Pack	4700870	4700880	4700885	4701070	-
Price	N/A -	N/A -	N/A -	N/A -	-
Finnpipette F3 Pack	-	-	-	-	4701290
Price	-	-	-	-	N/A -

Multi-channel F1 and F2 Finn pipettes

No. channel	Vol. (µl)	Increment (µl)	Suitable tips	Finnpipettes F1		Finnpipettes F2	
				Cat. No.	Price	Cat. No.	Price
8	1.0-10	0.02	Flex 10, 10, 50 micro	050660N	N/A-	050624	N/A-
8	5-50	0.1	Flex 200, 250 Univ, 200 length	050661N	N/A-	050625	N/A-
8	10-100	0.2	Flex 200, 250 Univ, 200 length	050662N	N/A-	050626	N/A-
8	30-300	1	Flex 300, 300	050663N	N/A-	050627	N/A-
12	1.0-10	0.02	Flex 10, 10, 50 micro	050664N	N/A-	050628	N/A-
12	5-50	0.1	Flex 200, 250 Univ, 200 length	050665N	N/A-	050629	N/A-
12	10-100	0.2	Flex 200, 250 Univ, 200 length	050666N	N/A-	050630	N/A-
12	30-300	1	Flex 300, 300	050667N	N/A-	050631	N/A-
16	1.0-10	0.02	Flex 10 (384), 50 micro	050668N	N/A-	050632	N/A-
16	5-50	0.1	50 micro	050669N	N/A-	050633	N/A-

Novus Electronic Finnpiettes

- **Balanced grip and power-assisted tip ejector**
- **Digital display, illuminated screen, for viewing all parameters**
- **10 pipetting functions:** direct or reverse, dilute, mix, repeat or sequential dispensing
- **9 pipetting and dispensing speeds**
- **Programmable according to the user's applications**
- **Recalibratable in laboratory according to ISO 8655 protocol**
- **Supplied with charger**
- **Autoclavable lower part**



Novus Single-channel

Volume (µl)	Increment (µl)	Suitable tips	Cat. No.	Price
1 - 10 micro	0.01	10 µl	047717	N/A -
1 - 10	0.01	250 µl universal, 200 length	047718	N/A -
5 - 50 micro	0.1	50 µl	047719	N/A -
5 - 50	0.1	250 µl universal, 200 length	047720	N/A -
10 - 100	0.1		047721	N/A -
30 - 300	1	Flex 300 µl	047722	N/A -
100 - 1000	1	1000 µl	047723	N/A -
500 - 5000	10	5 ml	047724	N/A -
1000 - 10000	10	10 ml	047725	N/A -

Novus Multi-channel

Volume (µl)	Increment (µl)	Suitable tips	Channels	Cat. No.	Price
1 - 10	0.1	10, 20, 50 µl	8	047263	N/A -
1 - 10	0.1		12	047264	N/A -
5 - 50	0.1	250 µl	8	047265	N/A -
5 - 50	0.1		12	047266	N/A -
5 - 50	0.5	50 µl	16	047267	N/A -
30 - 300	1	Flex 300 µl	8	047268	N/A -
30 - 300	1		12	047269	N/A -
100 - 1200	1		8	047270	N/A -

Accessory

Cat. No.	Description	Price
047270	Rack for Finnpiettes novus	N/A -

Novus Finnpiettes GLP Kits

Complete kits with 2 or 3 Novus Finnpiettes, racks and Finntips tips.

	kit GLP1 Novus	kit GLP2 Novus	kit GLP3 Novus	kit GLP4 Novus
Includes	- 1 Novus 10 - 100 µl - 1 Novus 100 - 1000 µl - 2 Novus racks - 2 Finntips Flex racks	- 1 Novus 100 - 1000 µl - 1 Novus 0.5 - 5 ml - 2 racks Novus - 2 Finntips Flex racks	- 1 Novus 1 - 10 µl micro - 1 Novus 10 - 100 µl - 1 Novus 100 - 1000 µl - 3 racks Novus - 3 Finntips Flex racks	- 1 Novus 10 - 100 µl - 1 Novus 100 - 1000 µl - 1 Novus 1 ml - 10 ml - 3 racks Novus - 3 Finntips Flex racks
Cat. No.	4700470	4700490	4701120	4701130
Price	N/A -	N/A -	N/A -	N/A -



Finntips sterile filter tips

Cat. No.	Finntip with filter	Volume	Racks	Price
047083	0.2 - 10 µl micro sterile	0.2 - 10 µl	10 x 96	N/A -
047084	384, 20 µl micro sterile	0.5 - 20 µl	10 x 384	N/A -
047601	384, 50 µl sterile	0.2 - 50 µl	10 x 384	N/A -
047086	10 µl sterile	0.5 - 10 µl	10 x 96	N/A -
047951	10 µl Flex sterile	0.5 - 10 µl	10 x 96	N/A -
047087	20 µl sterile	0.5 - 20 µl	10 x 96	N/A -
047856	30 µl Flex sterile	0.5 - 30 µl	10 x 96	N/A -
047089	100 µl long sterile	0.5 - 100 µl	10 x 96	N/A -
047088	100 µl sterile	0.5 - 100 µl	10 x 96	N/A -
047853	100 µl Flex sterile	0.5 - 100 µl	10 x 96	N/A -
047090	200 µl sterile	0.5 - 200 µl	10 x 96	N/A -
047091	200 µl ext. sterile	0.5 - 200 µl	10 x 96	N/A -
050698	200 µl Flex sterile	0.5 - 200 µl	10 x 96	N/A -
047092	300 µl sterile	5 - 300 µl	10 x 96	N/A -
047857	300 µl Flex sterile	5 - 300 µl	10 x 96	N/A -
047254	1000 µl sterile	100 - 1000 µl	10 x 96	N/A -
047255	1000 µl ext. sterile	100 - 1000 µl	5 x 96	N/A -
047854	1000 µl Flex sterile	100 - 1000 µl	10 x 96	N/A -
047855	1200 µl Flex sterile	100 - 1200 µl	10 x 96	N/A -
047259	1500 µl sterile	50 - 1500 µl	10 x 96	N/A -
047162	5 ml sterile	1 - 5 ml	5 x 54	N/A -
047096	10 ml sterile	2 - 10 ml	5 x 24	N/A -
047913	10 ml Flex sterile l=26.7 mm	2 - 10 ml	50	N/A -

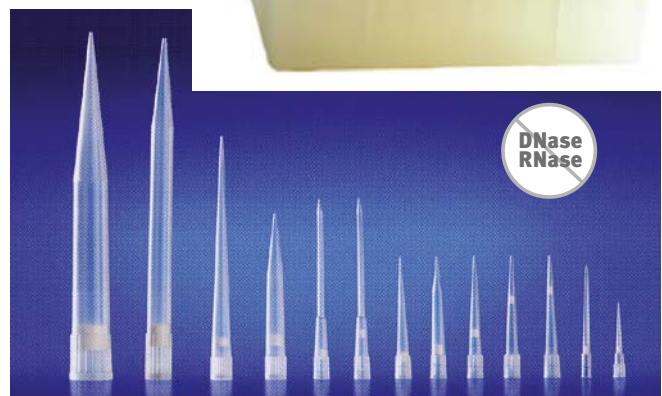

Finntips Tips



- Very high precision tips
- Flex tips are more flexible, have better adhesion to the pipette and a sharper tip
- Natural colour, colour-coded racks
- Sterile Finntip certified free of endotoxins, DNA, DNase and RNase (standard, filter and Biocon tips)
- Ext. model: extra long
- Racks with cover

Designation	Volume	Length (cm)	Code colour		Bag	on rack	on rack stérile	Refill	Box	Bulk eco	BioCon single sterile
Finntip 10 µl	0.2 - 10 µl	3.2	Pink	Pack.	1000 units	10 x 96	10 x 96	10 x 192* 20 x 192***	-	-	100
				Cat. No.	047042	047043	047044	047260 047257	-	-	047157
				Price	N/A -	N/A -	N/A -	N/A - N/A -	-	-	N/A -
Finntip 10 µl Flex	0.2 - 10 µl	3.3	Pink	Pack.	1000 units	10 x 96	10 x 96	- 20 x 96	-	-	-
				Cat. No.	047950A	047946	047947	- 047949	-	-	-
				Price	N/A -	N/A -	N/A -	- N/A -	-	-	-
Finntip 20 µl	0.2 - 20 µl	3.3	Purple	Pack.	1000 units	10 x 384	10 x 384	-	-	-	-
				Cat. No.	047045	047046	047047	-	-	-	-
				Price	N/A -	N/A -	N/A -	-	-	-	-
Finntip 50 µl	0.2 - 50 µl	4.8	Turquoise	Pack.	1000 units	10 x 384	10 x 384	-	-	-	-
				Cat. No.	047048	047602	047726	-	-	-	-
(For Finnpipette 10 µl and 16 channel 50 µl)				Price	N/A -	N/A -	N/A -	-	-	-	-
Finntip 200 µl ext.	5 - 200 µl	7.8	Orange	Pack.	-	10 x 96	10 x 96	-	Box of 400	-	-
				Cat. No.	-	047052	047053	-	047051	-	-
				Price	-	N/A -	N/A -	-	N/A -	-	-
Finntip 200 µl Flex	5 - 200 µl	6	Yellow	Pack.	1000 units	10 x 96	10 x 96	- 20 x 96	-	-	-
				Cat. No.	047274	047275	047276	- 047278	-	-	-
				Price	N/A -	N/A -	N/A -	- N/A -	-	-	-
Finntip 250 µl Universal	0.5 - 250 µl	5.2	Yellow	Pack.	1000 units	10 x 96	10 x 96	20 x 96	-	box of 500	100
				Cat. No.	047055	047057	047058	047059	-	047054	047158
				Price	N/A -	N/A -	N/A -	N/A -	-	N/A -	N/A -
Finntip 250 µl wide (large opening)	0.5 - 250 µl	5.2	White	Pack.	1000 units	10 x 96	10 x 96	-	-	-	-
				Cat. No.	047758	047760	047761	-	-	-	-
				Price	N/A -	N/A -	N/A -	-	-	-	-
Finntip 300 µl	5 - 300 µl	5.2	Orange	Pack.	1000 units	10 x 96	10 x 96	10 x 192	-	20 000	-
				Cat. No.	047060	047062	047063	047064	-	047061	-
				Price	N/A -	N/A -	N/A -	N/A -	-	N/A -	-
Finntip Flex 300 µl	5 - 300 µl	6.0	Orange	Pack.	1000 units	10 x 96	10 x 96	20 x 96	-	-	-
				Cat. No.	047755	047727	047728	047730	-	-	-
				Price	N/A -	N/A -	N/A -	N/A -	-	-	-
Finntip 1000 µl	100 - 1000 µl	7.1	Blue	Pack.	1000 units	10 x 96	10 x 96	5 x 192	box of 200	10 000	50
				Cat. No.	047065	047247	047248	047249	047067	047066	047159
				Price	N/A -	N/A -	N/A -	N/A -	N/A -	N/A -	N/A -
Finntip 1000 µl ext.	100 - 1000 µl	10.5	Blue	Pack.	1000	The 5 x 96	The 5 x 96	-	-	-	-
				Cat. No.	047071	047250	047251	-	-	-	-
				Price	N/A -	N/A -	N/A -	-	-	-	-
Finntip 1000 µl wide (large opening)	100 - 1000 µl	7.2	White	Pack.	400 units	10 x 96	10 x 96	-	-	-	-
				Cat. No.	047762	047764	047765	-	-	-	-
				Price	N/A -	N/A -	N/A -	-	-	-	-
Finntip 1000 µl Flex	100 - 1000 µl	8.7	Blue	Pack.	1000	10 x 96	10 x 96	2 x 8 x 96	-	-	-
				Cat. No.	047849	047848	047852	047850	-	-	-
				Price	N/A -	N/A -	N/A -	N/A -	-	-	-
Finntip 1200 µl Flex	50 - 1200 µl	8.7	Turquoise	Pack.	1000	10 x 96	10 x 96	2 x 8 x 96	-	-	-
				Cat. No.	047858	047756	047757	047953	-	-	-
				Price	N/A -	N/A -	N/A -	N/A -	-	-	-
Finntip 5 ml	1 - 5 ml	14.7	Green	Pack.	500 units	5 x 54	5 x 54	-	-	-	-
				Cat. No.	047075	047100	047101	-	-	-	-
				Price	N/A -	N/A -	N/A -	-	-	-	-
Finntip 10 ml	2 - 10 ml	15	Red	Pack.	100 units	5 x 24	5 x 24	-	-	-	-
				Cat. No.	047080	047081	047082	-	-	-	-
				Price	N/A -	N/A -	N/A -	-	-	-	-
Finntip 10 ml Flex Long	1 - 10 ml	26.7	Red	Pack.	100 units	-	50 (bulk)	-	-	-	-
				Cat. No.	047911	-	050716	-	-	-	-
				Price	N/A -	-	N/A -	-	-	-	-
Finntip Multistepper	1500 µl	8.5	Turquoise	Pack.	400 units	10 x 96	10 x 96	-	-	-	-
				Cat. No.	047170	047171	047172	-	-	-	-
				Price	N/A -	N/A -	N/A -	-	-	-	-
Finntip PDP 25	0.2 - 25 µl	3.7	Blue light	Pack.	960 units	10 x 96	-	-	-	-	-
				Cat. No.	047139	047140	-	-	-	-	-
				Price	N/A -	N/A -	-	-	-	-	-

Tips not shown to scale. Refer to the lengths (in cm) in the table.
* With 4 racks (Starter Kit) *** Loaded tray (without rack)

TIPS
MICROPIPETTES

Thermo Scientific micropipette racks



050672



Cat. No.	Description	Price
050634	Rack for 6 manual Finnpiettes, white	N/A -
047020	Rack for 6 manual Finnpiettes, grey	N/A -
047134	Rack for 3 manual Finnpiettes	N/A -
050672	Rack for a multi-channel manual Finnpiette	N/A -
047039	Carousel rack with bell for 3 manual or 3 electronic micropipettes	N/A -
047270	Rack for a Novus electronic pipette	N/A -
228596	Rack with integrated charger for 1 E1-ClipTip	N/A -
228653	Rack with integrated charger for 3 E1-ClipTip micropipettes	N/A -

Gilson micropipettes

Model	PIPETMAN® Classic	PIPETMAN® G	PIPETMAN® L	PIPETMAN® M
Operating mode	Manual	Manual	Manual	Motorized
Adjustable spacing between tips	No	No	No	No
Highlights	Lightweight and robust	light and robust, low pipetting and ejection force	Balanced weight, optimised grip and very low pipetting force	Lightweight, almost no pipetting force, easy to handle, automated pipetting
Volume range	0.2 µl - 10 ml	0.2 µl - 10 ml	0.5 µl - 10 ml	0.5 µl - 10 ml
Available options	1-channel	1 channel, 8 channel, 12 channel	1 channel, 8 channel, 12 channel	1 channel, 8 channel, 12 channel
RFID tracking	No	No	Yes	No
Autoclavable parts	Lower part and ejector	Lower part and ejector	Entirely	Lower part and ejector

PIPETMAN® Classic



- **Lightweight micropipette with optimised grip**
- **Robust, made of highly resistant materials such as PVDF and stainless steel**
- **Autoclavable lower part and ejector**
- **Also available in fixed volume, find them on our website**
- **Warranty: 3 years**



Volume (µl)	Suitable tips	Increment (µl)	Cat. No.	Price
0.2 - 2	D(F)L10	0.002	066001	N/A -
1 - 10		0.02	066002	N/A -
2 - 20	D200, DF30	0.02	066003	N/A -
20 - 100	D200, DF100	0.2	066004	N/A -
50 - 200	D(F)200, D(F)300	0.2	066005	N/A -
200 - 1000	D(F)1000, D(F)1200	2	066006	N/A -
1000 - 5000	D5000	2	066007*	N/A -
1000 - 10000	D10 ml	20	066008*	N/A -

Available with ISO 17025 calibration certificate (Cofrac approved).

* Only compatible with Gilson tips.

PIPETMAN® Classic Kits

	PIPETMAN® Classic Micro Volume Kit	PIPETMAN® Classic Starter Kit	PIPETMAN® Classic Large Volume Kit
Includes:	1 PIPETMAN® Classic P2 (0.2-2 µl) 1 PIPETMAN® Classic P10 (1-10 µl) 1 PIPETMAN® Classic P100 (10-100 µl) + Gilson Certificates + 2 racks 96 tips PIPETMAN® DIAMOND (DFL10ST, DF100ST) + 3 SINGLE racks + 1 Gilson pipetting guide	1 PIPETMAN® Classic P20 (2-20 µl) 1 PIPETMAN® Classic P200 (50-200 µl) 1 PIPETMAN® Classic P1000 (200-1000 µl) + Gilson Certificates + 2 racks 96 tips PIPETMAN® DIAMOND (D200, D1000) + 3 SINGLE racks + 1 Gilson pipetting guide	1 PIPETMAN® Classic P5000 (1000-5000 µl) 1 PIPETMAN® Classic P10ml (1-10 ml) + Gilson Certificates + 5 tips PIPETMAN® DIAMOND D5000 + 2 tips PIPETMAN® DIAMOND D10 ml + 2 x 10 protective filters for P5000 and P10 ml
Cat. No.	066085	066086	066087
Price	N/A -	N/A -	N/A -

PIPETMAN® G



- **Lightweight micropipette requiring low pipetting and ejection force**
- **Equipped with metal ejector, plastic ejector available as accessory for working with corrosive samples**
- **Robust, made of highly resistant materials such as PVDF and stainless steel**
- **Autoclavable lower part and ejector**
- **Warranty: 3 years**



PIPETMAN® G - Single-channel variable volume

Volume (µl)	Suitable tips	Increment (µl)	Cat. No.	Price
0.2 - 2	D(F)L10	0.002	066803	N/A -
1 - 10		0.02	066805	N/A -
2 - 20	D200, DF30	0.02	066807	N/A -
20 - 100	D200, DF100	0.2	066809	N/A -
50 - 200	D(F)200, D(F)300	0.2	066811	N/A -
200 - 1000	D(F)1000, D(F)1200	2	066813	N/A -
1000 - 5000	D5000	2	066814**	N/A -
1000 - 10000	D10ml	20	066815**	N/A -

Available with ISO 17025 calibration certificate (Cofrac approved).

** Only compatible with Gilson tips, model without ejector.

PIPETMAN® G - Multi-channel variable volume

Volume (µl)	Suitable tips	Increment (µl)	8-channel		12-channel	
			Cat. No.	Price	Cat. No.	Price
1 - 10	D(F)L10	0.02	400083	N/A -	400084	N/A -
2 - 20	D(F)L10, D200, DF30	0.02	400086	N/A -	400087	N/A -
20 - 200	D(F)200, D(F)300	0.2	400088	N/A -	400089	N/A -
20 - 300		0.2	400090	N/A -	400091	N/A -

Available with ISO 17025 calibration certificate (Cofrac approved).

PIPETMAN® G (continued)

PIPETMAN® G Kits

	PIPETMAN® G Micro Volume Kit	PIPETMAN® G Starter Kit	Kit 4 PIPETMAN® G
Includes	1 PIPETMAN® G P2G (0.2 - 2 µl) 1 PIPETMAN® G P10G (1 - 10 µl) 1 PIPETMAN® G P100G (10 - 100 µl) (metal ejectors) + Gilson certificates + 2 racks 96 tips PIPETMAN® DIAMOND (DFL10ST, DF100ST) + 3 SINGLE racks + 10 colour clips + 3 plastic ejectors	1 PIPETMAN® G P20G (2 - 20 µl) 1 PIPETMAN® G P200G (20 - 200 µl) 1 PIPETMAN® G P1000G (100 - 1000 µl) (metal ejectors) + Gilson certificates + 2 racks 96 tips PIPETMAN® DIAMOND (D200, D1000) + 3 SINGLE racks + 10 colour clips + 3 plastic ejectors	1 PIPETMAN® G P2G (0.2 - 2 µl) 1 PIPETMAN® G P20G (2 - 20 µl) 1 PIPETMAN® G P200G (20 - 200 µl) 1 PIPETMAN® G P1000G (100 - 1000 µl) + 2 racks 96 tips PIPETMAN® DIAMOND (DL10, D200, D1000) + 4 individual racks + 4 comfort handles + stickers + 1 pipetting guide + 1 2-minute inspection poster + 1 manual
Cat. No.	066825	066826	070175
Price.	N/A -	N/A -	N/A -



PIPETMAN® L

- **Balanced weight and design for easy handling**
- **Reduced pipetting force**
- **Adjustable ejector button to suit left and right handed users**
- **Volumetric locking mechanism prevents accidental volume change during pipetting**
- **Single channel micropipettes available with metal or plastic ejector for working with corrosive samples**
- **2D code for easy traceability during handling and maintenance**
- **Variable volume micropipette fully autoclavable without disassembly**
- **Warranty: 1 year**

PIPETMAN® L - Single-channel variable volume

Volume (µl)	Suitable tips	Increment (µl)	Metal ejector		Plastic ejector	
			Cat. No.	Price	Cat. No.	Price
0.2 - 2	D(F)L10	0.002	070047	N/A -	070053	N/A -
1 - 10		0.02	070048	N/A -	070054	N/A -
2 - 20	D200, DF30	0.02	070049	N/A -	070055	N/A -
10 - 100	D200, DF100	0.2	070050	N/A -	070056	N/A -
20 - 200	D(F)200, D(F)300	0.2	070051	N/A -	070057	N/A -
100 - 1000	D(F)1000, D(F)1200	2	070052	N/A -	070058	N/A -
500 - 5000	D5000	2	070059*		N/A -	
1000 - 10000	D10 ml	20	070060*		N/A -	

Available with ISO 17025 calibration certificate (Cofrac approved).

*Only compatible with Gilson tips, model without ejector.

PIPETMAN® L - Multi-channel variable volume

Volume (µl)	Suitable tips	Increment (µl)	8-channel		12-channel	
			Cat. No.	Price	Cat. No.	Price
0.5 - 10	D(F)L10	0.02	070063	N/A -	070064	N/A -
2 - 20	D(F)L10, D200, DF30	0.02	070065	N/A -	070066	N/A -
20 - 200	D(F)200, D(F)300	0.2	070067	N/A -	070068	N/A -
20 - 300		0.2	070069	N/A -	070070	N/A -
100 - 1200	D(F)1200	2	067538	N/A -	067536	N/A -

Available with ISO 17025 calibration certificate (Cofrac approved)

(add a C behind the reference).



PIPETMAN® L it

Cat. No.	Description	Pipettes	96-tip DIAMOND rack	Accessories	Price
070098	PIPETMAN® Metal ejector Starter kit	P20L P200L P1000L	D200 D1000	3 SINGLE racks 3 plastic ejectors 1 user guide	N/A -
070099	PIPETMAN® Metal ejector Micro-volume kit	P2L P10L P100L	DL10 D200	1 pipetting guide 1 quick inspection poster	N/A -
070174	Kit 4 PIPETMAN® L metal ejector	P2L P20L P200L P1000L	DL10 DL200 DL1000	4 individual racks, 1 pipetting guide, 1 2-minute inspection poster, 1 user manual	N/A -

PIPETMAN® M Connected



- ▶ Motorised micropipette requiring almost no pipetting force and preserving the gestures associated with a mechanical pipette
- ▶ Lightweight, low ejection force and ergonomic design
- ▶ Lockable volume
- ▶ Simple and intuitive operation with digital display on OLED screen
- ▶ 4 pipetting modes: pipette, repeat, mix and invert
- ▶ The PIPETMAN® M Connected software allows you to create and transfer up to 10 custom protocols
- ▶ Rechargeable battery in just 3 hours for up to 900 pipetting cycles
- ▶ Can be used while charging
- ▶ Can be connected to the optional Trackman® Connected to help reduce human error, track pipetting or archive calibration data
- ▶ Autoclavable lower part and ejector
- ▶ Volumetric specification according to ISO 8655-2
- ▶ Warranty: 1 year

Single channel

Volume (µl)	Suitable tips	Cat. No.	Price
0.5 - 10	D(F)L10	067516	N/A -
2 - 20	D200, DF30	067517	N/A -
5-100	D200,DF100	067518	N/A -
20 - 200	D(F)200, D(F)300	067519	N/A -
20 - 300		067520	N/A -
100 - 1200	D(F)1000, D(F)1200	067521	N/A -
500 - 5000	D5000	067522	N/A -
100 - 10000	D10ml	067523	N/A -

Multichannel

Volume (µl)	Suitable tips	8-channel		12-channel	
		Cat. No.	Price	Cat. No.	Price
0.5 - 10	D(F)L10	067524	N/A -	067525	N/A -
1 - 20	D(F)L10, D200, DF30	067526	N/A -	067527	N/A -
10-100	D200,DF100	067528	N/A -	067529	N/A -
20 - 200	D(F)200, D(F)300	067530	N/A -	067531	N/A -
10 - 300		067532	N/A -	067533	N/A -
50 - 1200	D(F)1000, D(F)1200	067534	N/A -	067535	N/A -



Trackman® Connected



- ▶ Tablet with exclusive accessories and applications to connect to the pipetman® M connected
- ▶ Tracks pipetting on 96 and 384 well plates to avoid errors
- ▶ Interacts in real time with the PIPETMAN® M connected to guide the user through the protocol
- ▶ Recording and sharing of results and protocols
- ▶ Monitoring of usage statistics and calibration data history
- ▶ Supplied with a microplate holder, microplate adapter and PCR strip; and a sensor to monitor temperature, pressure and humidity during handling

Cat. No.	Description	Price
400115	Trackman® Connected	N/A -

Gilson PIPETMAN® DIAMOND Tips

Ergonomics
Tip and mouthpiece PIPETMAN® fit perfectly together; less effort is required to insert and eject the tips

Graduations
Volume control at a glance

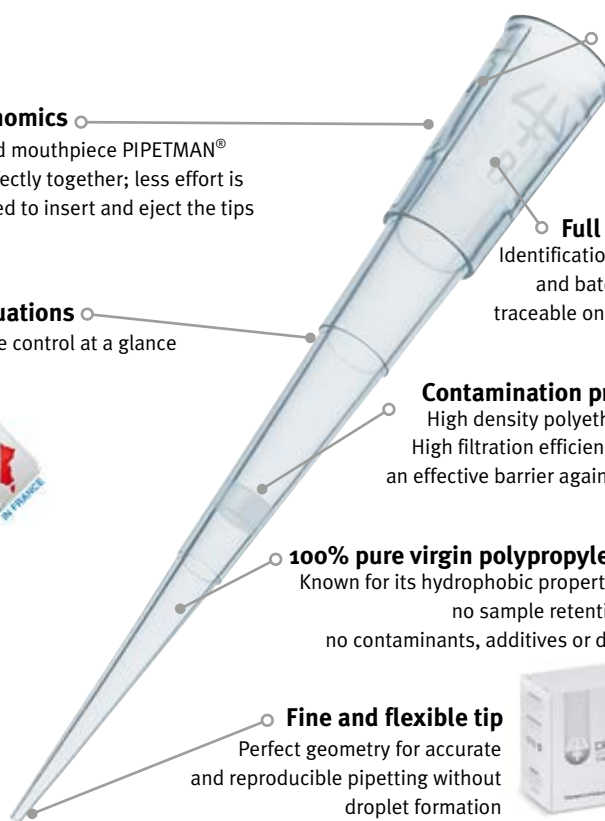

Perfectly sealed
Sealing ring ensures reliability and reproducibility with every pipetting operation

Full traceability
Identification, colour code and batch number are traceable on each package

Contamination prevention
High density polyethylene filter
High filtration efficiency provides an effective barrier against aerosols

100% pure virgin polypropylene
Known for its hydrophobic properties; no sample retention; no contaminants, additives or dyes

Fine and flexible tip
Perfect geometry for accurate and reproducible pipetting without droplet formation

- Sterilized tips guaranteed free of RNases, DNases, RNA, DNA, ATP, pyrogens and detectable trace metals
- Meets European quality standards IVD Directive 98/79/EC (CE-IVD marking)
- Downloadable quality certificates on the Gilson website

Presentation:

- **TOWERPACK**, charging system. Ideal with multichannel pipettes thanks to the ROCKY RACK system, a tray that optimises the placement of the tips. Autoclavable, recyclable. (must be completed with empty boxes Cat. No. 066173 - see bottom of page)
- **TIPACK**, compact, practical, ergonomic and easy to use racks with 8 or 12 channel pipettes (ROCKY RACK system)
- **STERILPACK**, individually blister-packed
- **ECOPACK** and **EASYPACK**, bulk format (bags)
- **BLISTER REFILL**: refill in blister pack of 96 tips
- **RELOAD PACK**: simple and economical reload system



Gilson PIPETMAN® DIAMOND Standard Tips

Volume	Type		Bulk EASY PACK	Bulk Eco ECO PACK	TIPACK	TIPACK sterilised	BLISTER REFILL*	BLISTER REFILL sterilised*	RELOAD PACK*	TOWER PACK**	TOWER PACK sterilised**	Empty rack	STERILPACK
0.1 - 10 µl	D10	Cat. No.	066022	066029	066034	066039	-	-	-	066044	066049	066054	-
		Packaging unit	5 x 200	10000	10 x 96	10 x 96	-	-	-	10 x 96	10 x 96	2	-
		Price	N/A -	N/A -	N/A -	N/A -	-	-	-	N/A -	N/A -	N/A -	-
0.1 - 20 µl	DL10***	Cat. No.	066023	066030	066035	066040	070074	070077	070085	066045	066050	066055	-
		Packaging unit	5 x 200	10000	10 x 96	10 x 96	10 x 96	10 x 96	10 x 96	10 x 96	10 x 96	2	-
		Price	N/A -	N/A -	N/A -	N/A -	N/A -	N/A -	N/A -	N/A -	N/A -	N/A -	-
2 - 200 µl	D200	Cat. No.	066024	066031	066036	066041	070075	070078	070086	066046	066051	066056	066199
		Packaging unit	5 x 200	10000	10 x 96	10 x 96	10 x 96	10 x 96	10 x 96	10 x 96	10 x 96	2	400
		Price	N/A -	N/A -	N/A -	N/A -	N/A -	N/A -	N/A -	N/A -	N/A -	N/A -	N/A -
20 - 300 µl	D300	Cat. No.	066025	066032	066037	066042	-	-	-	066047	066052	066057	-
		Packaging unit	5 x 200	10000	10 x 96	10 x 96	-	-	-	10 x 96	10 x 96	2	-
		Price	N/A -	N/A -	N/A -	N/A -	-	-	-	N/A -	N/A -	N/A -	-
200 - 1000 µl	D1000	Cat. No.	066026	066033	066038	066043	070076	070079	070087	066048	066053	066058	066200
		Packaging unit	5 x 200	10000	10 x 96	10 x 96	10 x 96	10 x 96	6 x 96	7 x 96	7 x 96	2	400
		Price	N/A -	N/A -	N/A -	N/A -	N/A -	N/A -	N/A -	N/A -	N/A -	N/A -	N/A -
100 - 1200 µl	D1200	Cat. No.	066406	066405	066407	066408	-	-	-	-	-	-	-
		Packaging unit	5 x 200	10000	10 x 96	10 x 96	-	-	-	-	-	-	-
		Price	N/A -	N/A -	N/A -	N/A -	-	-	-	-	-	-	-
1 - 5 ml	D5000	Cat. No.	066027	-	066190	-	-	-	-	-	-	066193	-
		Packaging unit	3 x 334	-	12 x 50	-	-	-	-	-	-	1	-
		Price	N/A -	-	N/A -	-	-	-	-	-	-	N/A -	-
1 - 10 ml	D10ml	Cat. No.	066028	-	066191	-	-	-	-	-	-	066192	-
		Packaging unit	4 x 50	-	8 x 30	-	-	-	-	-	-	1	-
		Price	N/A -	-	N/A -	-	-	-	-	-	-	N/A -	-

* Can be used with empty boxes for manual refills
** Can be used with empty TOWER PACK refill boxes
*** Longer 10µl tips, for easy pipetting into microtubes



Place the tower on the refill box. Press firmly.



The tip tray is in place.

Empty boxes

Cat. No.	Description	Units/box	Price/box
070096	Empty box for 10 µl and 200 µl manual refills	2	N/A -
070097	Box empty for manual refills 1000 µl	2	N/A -
066173	Universal empty box for TOWER PACK refill	1	N/A -

TIPS MICROPIPETTES

Gilson PIPETMAN® DIAMOND Filter Tips

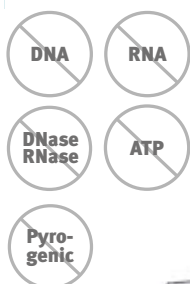

Gilson PIPETMAN® DIAMOND Tips, guarantee the precision, accuracy and repeatability specifications of your PIPETMAN®.

► Free of trace metals

► Meets European quality standards IVD Directive 98/79/EC (CE-IVD marking)

► Quality certificates can be downloaded from the Gilson website

Volume (µl)	Type		TIPACK sterilised	BLISTER REFILL sterilised*
0.1 - 10	DF10	Cat. No.	066059	-
		Price/ 960 units	N/A -	-
0.1 - 10	DFL10**	Cat. No.	066060	070080
		Price/ 960 units	N/A -	N/A -
2 - 30	DF30	Cat. No.	066061	070081
		Price/ 960 units	N/A -	N/A -
20 - 100	DF100	Cat. No.	066062	070082
		Price/ 960 units	N/A -	N/A -
20 - 200	DF200	Cat. No.	066063	070083
		Price/ 960 units	N/A -	N/A -
20 - 300	DF300	Cat. No.	066064	-
		Price/ 960 units	N/A -	-
200 - 1000	DF1000	Cat. No.	066065	070084
		Price/ 960 units	N/A -	N/A -
100 - 1200	DF1200ST	Cat. No.	066603	-
		Price/ 960 units	N/A -	-

Identification ring



► Identification ring in different colours to identify or personalise your PIPETMAN®

► Attaches easily without damaging the micropipette

Colour	Red	Yellow	Green	Blue	White	Assorted
Cat. No.	066093	066094	066095	066096	066097	066098
Price/ 10 units	N/A -	N/A -	N/A -	N/A -	N/A -	N/A -

Comfort handle for PIPETMAN® Classic and G



Easy attachment to pipetman Classic and G to reduce fatigue and improve comfort

Cat. No.	Description	Units/ box	Price/ box
070168	Blue comfort handle	3	N/A -
070169	White comfort handle	3	N/A -
944894	Self-adhesive foil for comfort handle	120	N/A -

Plastic ejectors for PIPETMAN® Classic and G



Recommended for working with corrosive samples.

Cat. No.	Description	Price
400093	Plastic ejector for P2 and P20	N/A -
400094	Plastic ejector for P20	N/A -
400095	Plastic ejector for P100	N/A -
400096	Plastic ejector for P200	N/A -
400097	Plastic ejector for P1000	N/A -

Jimmy Microtube Opener



Clipped onto the PIPETMAN, this accessory facilitates the opening of microtubes with a screw cap or tab.

Cat. No.	Description	Price 3 units
066602	Jimmy Microtube Opener for PIPETMAN	N/A -

Racks and carousels for PIPETMAN®



Cat. No.	Description	Price
066090	Wall rack for a PIPETMAN® (single or multi-channel)*	N/A -
066798	Universal holder for an 8 or 12 channel micropipette	N/A -
066089	Holder for three Gilson single-channel micropipettes	N/A -
066817	Carousel for 5 PIPETMAN® M with integrated charger	N/A -
066088	Carousel for 7 micropipettes	N/A -

* Supplied with double-sided adhesive tape and screws.

GILSON AFTER-SALES PACKAGE COUPON

The purchase of an after-sales coupon allows, for a single fixed price, to return a Gilson micropipette to Gilson SAS, for calibration, repair whatever the nature of the failure, without requesting a quote or additional costs. Valid for PIPETMAN® Classic and PIPETMAN® Neo from P2 to P1000 single channel only (P5000 and P10 ml are excluded).

Cat. No.	Price
066666	N/A -



(coupon valid for 1 year from the date of purchase)

Proline single-channel micropipettes

- High-performance, robust and easy-to-handle micropipettes
- Warranty: 2 years



Proline single channel micropipettes - variable volume

Volume (µl)	Increment (µl)	Cat. No.	Price
0.1 - 2.5	0.05	070599	N/A -
0.5 - 10	0.1	070600	N/A -
2 - 20	0.5	070601	N/A -
5 - 50	0.5	070602	N/A -
10 - 100	1	070603	N/A -
20 - 200	1	070604	N/A -
100 - 1000	5	070606	N/A -
1000 - 5000	50	070608	N/A -



Sartorius Biohitfamily Proline Plus micropipettes

- Effortless pipetting, ergonomic grip
- Easy insertion and removal of tips with the OptiLoad system (on multichannel only)
- Fine incrementing
- Fully autoclavable without disassembly
- Use with "SafeCone" protective filters to protect the pipette and your samples from aerosols
- Warranty: 2 years

Single channel - fixed volume

Volume (µl)	Cat. No.	Price
5	070851	N/A -
10	070852	N/A -
20	070853	N/A -
25	070854	N/A -
50	070855	N/A -
100	070856	N/A -
200	070857	N/A -
250	070858	N/A -
500	070859	N/A -
1000	070860	N/A -
2000	070861	N/A -
5000	070862	N/A -
10000	070863	N/A -



Single channel - variable volume

Volume (µl)	Increment (µl)	Price	Price
0.1 - 3	0.002	070837	N/A -
0.5 - 10	0.01	070838	N/A -
2 - 20	0.02	070839	N/A -
5 - 50	0.1	070918	N/A -
10 - 100	0.1	070840	N/A -
20 - 200	0.2	070841	N/A -
100 - 1000	1	070842	N/A -
500 - 5000	10	070843	N/A -
1 - 10000	20	070844	N/A -

Multichannel

Volume (µl)	Increment (µl)	8-channel		12-channel	
		Cat. No.	Price	Cat. No.	Price
0.5 - 10	0.01	070845	N/A -	070848	N/A -
10 - 100	0.1	070846	N/A -	070849	N/A -
30 - 300	0.2	070847	N/A -	070850	N/A -

Proline Plus Multipacks

- The pack includes:
 - A set of tips;
 - A linear rack to store your pipettes vertically and away from contamination.

Pipettes included in the pack	0.5 - 10 µl 10 - 100 µl 100 - 1000 µl	2 - 20 µl 20 - 200 µl 100 - 1000 µl	0.5 - 10 µl 2 - 20 µl 20 - 200 µl 100 - 1000 µl	0.5 - 10 µl 10 - 100 µl 20 - 200 µl 100 - 1000 µl	0.5 - 10 µl 10 - 100 µl 20 - 200 µl 100 - 1000 µl 500 - 5000 µl	2 - 20 µl 10 - 100 µl 20 - 200 µl 100 - 1000 µl 500 - 5000 µl	0.5 - 10 µl 20 - 200 µl 100 - 1000 µl 8-channel 30 - 300 µl	100 - 1000 µl 500 - 5000 µl 1000 - 10000 µl
Tips supplied in the pack (one rack of 96 unless otherwise stated)	0.1 - 10 µl 0.5 - 200 µl 10 - 1000 µl	0.5 - 200 µl 10 - 1000 µl	0.1 - 10 µl 0.5 - 200 µl 10 - 1000 µl	0.1 - 10 µl 0.5 - 200 µl 10 - 1000 µl	0.1 - 10 µl 0.5 - 200 µl 10 - 1000 µl 100 - 5000 µl*	0.5 - 200 µl 10 - 1000 µl 100 - 5000 µl*	0.1 - 10 µl 0.5 - 200 µl 5 - 350 µl 10 - 1000 µl	10 - 1000 µl 100 - 5000 µl* 500 - 10000 µl**
Cat. No.	070867B	070868B	150070	150071	725694	150072	150073	150074
Price	N/A -	N/A -	N/A -	N/A -	N/A -	N/A -	N/A -	N/A -



* 50-tip box ** 35-tip box

TIPS
MICROPIPETTES

Sartorius Biohitfamily Tacta micropipettes



- ▶ Ergonomic shape for a comfortable grip
- ▶ Optimised pipetting and ejection system
- ▶ Exclusive Optilock system for volume adjustment and locking
- ▶ Soft and controlled release of the tips thanks to the new exclusive Optijec technology
- ▶ Adjustment key for precise volume according to the type of liquid being pipetted
- ▶ Easy to clean by removing only three components
- ▶ Fully autoclavable without disassembly
- ▶ Filter mounted in the cone holder to protect the pipette from aerosols and chemical attack
- ▶ Warranty: 2 years

Tacta single channel micropipettes - variable volume

Volume (µl)	Increment (µl)	Cat. No.	Price
0.1 - 3	0.002	070983	N/A -
0.5 - 10	0.01	070984	N/A -
0.2 - 20	0.02	070985	N/A -
10 - 100	0.10	070986	N/A -
20 - 200	0.2	070987	N/A -
100 - 1000	1	070988	N/A -
500 - 5000	5	070989	N/A -
1000 - 10000	10	070990	N/A -

Tacta multi-channel pipettes

Volume (µl)	Increment (µl)	8-channel		12-channel	
		Cat. No.	Price	Cat. No.	Price
0.5 - 10	0.01	070991	N/A -	070994	N/A -
5 - 100	0.1	070992	N/A -	070995	N/A -
30 - 300	0.2	070993	N/A -	070996	N/A -

Tacta Multipacks



- ▶ Pack content
 - One set of pipettes
 - An individual rack for each pipette in the pack, and a portal rack
 - A set of tips

Pipettes included in the pack	0.5 - 10 µl 10 - 100 µl 100 - 1000 µl	2 - 20 µl 20 - 200 µl 100 - 1000 µl	0.5 - 10 µl 2 - 20 µl 20 - 200 µl 100 - 1000 µl	0.5 - 10 µl 10 - 100 µl 20 - 200 µl 100 - 1000 µl	0.5 - 10 µl 10 - 100 µl 20 - 200 µl 100 - 1000 µl 500 - 5000 µl	2 - 20 µl 10 - 100 µl 20 - 200 µl 100 - 1000 µl 500 - 5000 µl	0.5 - 10 µl 20 - 200 µl 100 - 1000 µl 8 channel 30 - 300 µl	100 - 1000 µl 500 - 5000 µl 1 - 10 ml
Tips supplied in the pack (one rack of 96 unless otherwise stated)	0.2 - 10 µl 0.5 - 200 µl 10 - 1000 µl	0.5 - 200 µl 10 - 1000 µl	0.1 - 10 µl 0.5 - 200 µl 10 - 1000 µl	0.1 - 10 µl 0.5 - 200 µl 10 - 1000 µl	0.5 - 200 µl 10 - 1000 µl 5000 µl *	0.5 - 200 µl 10 - 1000 µl 5000 µl *	0.1 - 10 µl 0.5 - 200 µl 5 - 350 µl 10 - 1000 µl	10 - 1000 µl 0.1 - 5 ml** 1 - 10 ml***
Cat. No.	725686	725687	725688	725689	725690	725691	725692	725693
Price	N/A -	N/A -	N/A -	N/A -	N/A -	N/A -	N/A -	N/A -

* 50-tip box ** 100-tip bag *** 250-tip bag

Sartorius Biohitfamily mLINE micropipettes

- Excellent ergonomics with reduced pipetting force and tip ejection
- Enhanced safety with volumeter lock to prevent accidental volume change during pipetting
- Fully autoclavable
- SafeCone protective filter to minimise the risk of contamination
- Warranty: 2 years

Single channel - variable volume

Volume (µl)	Increment (µl)	Cat. No.	Price
0.1 - 3	0.02	070806	N/A -
0.5 - 10	0.01	070430	N/A -
02 - 20	0.2	070486	N/A -
10 - 100	0.1	070431	N/A -
20 - 200	0.2	070432	N/A -
100 - 1000	1	070433	N/A -
500 - 5000	10	070434	N/A -
1000 - 10000	20	070833	N/A -

Multichannel

Volume (µl)	Increment (µl)	mLINE 8 channel		mLINE 12 channel	
		Cat. No.	Price	Cat. No.	Price
0.5 - 10	0.01	070447	N/A -	070451	N/A -
5 - 100	0.1	070448	N/A -	070452	N/A -
30 - 300	0.2	070449	N/A -	070453	N/A -

mLINE Multipacks

- **The pack includes:**
 - a set of pipettes;
 - a set of tips;
 - a linear rack to store your pipettes vertically and away from contamination.

Pipettes included in the pack	2 - 20 µl, 20 - 200 µl, 100 - 1000 µl	0.5 - 10 µl, 10 - 100 µl, 20 - 200 µl, 100 - 1000 µl
Tips supplied in the pack (one rack of 96 unless otherwise stated)	0.5 - 200 µl, 10 - 1000 µl	0.2 - 10 µl, 0.5 - 200 µl, 10 - 1000 µl
Cat. No.	725662	725663
Price	N/A -	N/A -



TIPS
MICROPIPETTES

Sartorius Biohitfamily Picus and Picus NxT electronic pipettes



- Lightweight, weighing less than 100 g
- Ergonomic and comfortable, good grip (very short: 210 mm)
- Electronic tip ejection
- Optiload system for perfect attachment of the tips to each cone holder (multi-channel)
- Volume locked with push button
- Full choice of pipetting modes, from dilution with mixing to sequential dispensing
- Unique integrated tracker system for 96 and 384 well microplates guiding the user to the correct wells
- Adjustable calibration in 1, 2 or 3 points
- Ability to continue working while charging via microUSB cable
- Li-polymer batteries, charging time 1 hour
- Autoclavable lower part except for the 1250 µl
- Warranty: 2 years
- Picus NxT model:
 - repeated emptying to help dispense the last drops
 - password protection for program protection
 - supplied with 3-point calibration certificate (ISO 17025 and ISO 8655)
 - possibility to create custom programs

Picus single-channel and Picus NxT single-channel micropipettes

Volume (µl)	Increment (µl)	Picus Single-channel		Picus NxT single-channel	
		Cat. No.	Price	Cat. No.	Price
0.2 - 10	0.01	070927	N/A -	725666	N/A -
5 - 120	0.1	070928	N/A -	725667	N/A -
10 - 300	0.2	070929	N/A -	725668	N/A -
50 - 1200	1	070930	N/A -	725669	N/A -
100 - 5000	5	070931	N/A -	725670	N/A -
500 - 10000	10	070932	N/A -	725671	N/A -

Picus multichannel and Picus NxT multichannel micropipettes

Volume (µl)	Increment (µl)	Picus Multi-channel				Picus NxT multi-channel			
		8-channel		12-channel		8-channel		12-channel	
		Cat. No.	Price	Cat. No.	Price	Cat. No.	Price	Cat. No.	Price
0.2 - 10	0.01	070933	N/A -	070937	N/A -	725672	N/A -	725676	N/A -
5 - 120	0.1	070934	N/A -	070938	N/A -	725673	N/A -	725677	N/A -
10 - 300	0.2	070935	N/A -	070939	N/A -	725674	N/A -	725678	N/A -
50 - 1200	1	070936	N/A -	070940	N/A -	725675	N/A -	725679**	N/A -

** Compatible only with Sartorius BiohitfamilyTips.

Tips

High precision tips especially designed for Sartorius Biohitfamily micropipettes.

Tips in racks

- 96-Tip tray in reusable racks
- Certified DNase, RNase and endotoxin free
- Autoclavable
- Easily refillable racks with refill tips
- Polypropylene racks, trays and tips



FlexiBulk bulk tips

- Autoclavable
- Tips (PP) and packaging (PET) 100% recyclable



Tips in racks

- Space saving with 10 x 96 tips in one tower
- Trays compatible with single racks
- Autoclavable trays and tips
- 100% recyclable cardboard packaging and polypropylene trays and tips



Tips in bulk in boxes

- Autoclavable
- 100% recyclable tips and packaging



Unitary refill boxes

- 10, 15 or 20 trays of 96 tips, depending on the volume of the tips
- Certified DNase, RNase and endotoxin free
- Trays compatible with single racks
- Autoclavable trays and tips
- 100% recyclable polypropylene trays and tips



Sterile filter tips "SafetySpace" Sartorius Biohitfamily

- In 96-tip sterile rack
- More space between the sample and the filter
- No contact between sample and filter, regardless of pipetting method or liquid type

Tips	Volume (µl)	Length (mm)	Colour code	Units/box	Cat. No.	Price/box
	0.1 - 10	31.5	Grey	10 x 96	070881	N/A -
		46	Grey	10 x 96	070975*	N/A -
	0.5 - 20	51	Yellow	10 x 96	070884	N/A -
		77.5	Yellow	10 x 96	070951*	N/A -
	2 - 120	51	Yellow	10 x 96	845145	N/A -
					070880	N/A -
	5 - 200	52.5	Yellow	10 x 96	070976*	N/A -
					070883	N/A -
	5 - 300	52.5	Orange	10 x 96	070950*	N/A -
					783207	N/A -
	50 - 1000	78	Blue	10 x 96	070977*	N/A -
					845146	N/A -
	10 - 1000	102	Blue	8 x 96	783208	N/A -
					070978*	N/A -
	50 - 1200	90	Violet	10 x 96	070677	N/A -
					070979*	N/A -









TIPS
MICROPIPETTES

* Low retention

Tips not shown to scale. Refer to the lengths (in mm) in the table.

Tips "Optifit" Sartorius Biohitfamily

Volume (µl)	Length (mm)	Colour code		In a rack	In a rack Sterile	In a rack LowRes	In charging tower	In charging tower LowRes	Singles refill boxes	Singles refill boxes Sterile	Bulk in boxes	Bulk FlexiBulk	
0.1 - 10 	31.5	Grey	Cat. No.	070465	070466	070966	070467	070967	-	070905	070647	070647	
			Units/box	10 x 96	10 x 96	10 x 96	10 x 96	10 x 96	-	20 x 96	1000	1000	
			Price/box	N/A -	N/A -	N/A -	N/A -	N/A -	-	N/A -	N/A -	N/A -	
0.1 - 10	46	Grey	Cat. No.	070921	070922	-	-	-	-	-	-	-	
			Units/box	10 x 96	10 x 96	-	-	-	-	-	-	-	
			Price/box	N/A -	N/A -	-	-	-	-	-	-	-	
0.5 - 200 	51	Yellow	Cat. No.	070468	070469	070968	070473	070969	-	070906	-	725680	
			Units/box	10 x 96	10 x 96	10 x 96	10 x 96	10 x 96	-	15 x 96	-	960	
			Price/box	N/A -	N/A -	N/A -	N/A -	N/A -	-	N/A -	-	N/A -	
0.5 - 200	77.5	Yellow	Cat. No.	150077	150078	-	-	-	-	-	-	-	
			Units/box	10 x 96	10 x 96	-	-	-	-	-	-	-	
			Price/box	N/A -	N/A -	-	-	-	-	-	-	-	
5 - 350	54	Orange	Cat. No.	070474	070475	070970	070476	070971	-	070907	-	725681	
			Units/box	10 x 96	10 x 96	10 x 96	10 x 96	10 x 96	-	15 x 96	-	960	
			Price/box	N/A -	N/A -	N/A -	N/A -	N/A -	-	N/A -	-	N/A -	
10 - 1000 	71.5	Blue	Cat. No.	070477	070478	070972	-	-	070479	070908	-	725682	
			Units/box	10 x 96	10 x 96	10 x 96	-	-	10 x 96	10 x 96	-	480	
			Price/box	N/A -	N/A -	N/A -	-	-	N/A -	N/A -	-	N/A -	
10 - 1000	102	Blue	Cat. No.	150079	150080	-	-	-	-	-	-	-	
			Units/box	8 x 96	8 x 96	-	-	-	-	-	-	-	
			Price/box	N/A -	N/A -	-	-	-	-	-	-	-	
10 - 1000 	68.5	Turquoise	Cat. No.	070788	070789	-	-	-	-	-	-	725683	
			Units/box	10 x 96	10 x 96	-	-	-	-	-	-	480	
			Price/box	N/A -	N/A -	-	-	-	-	-	-	N/A -	
50 - 1200 	71.5	Violet	Cat. No.	070480	070481	070973	-	-	070482	070909	-	725684	
			Units/box	10 x 96	10 x 96	10 x 96	-	-	10 x 96	10 x 96	-	480	
			Price/box	N/A -	N/A -	N/A -	-	-	N/A -	N/A -	-	N/A -	
50 - 1200 	90	Violet	Cat. No.	070678	070679	070974	-	-	070924	070910	-	-	
			Units/box	10 x 96	10 x 96	10 x 96	-	-	10 x 96	10 x 96	-	-	
			Price/box	N/A -	N/A -	N/A -	-	-	N/A -	N/A -	-	-	
100 - 5000 	150	Green	Cat. No.	070793	070680	-	-	-	-	-	070666	070485	
			Units/box	50	50	-	-	-	-	-	-	100	1000
			Price/box	N/A -	N/A -	-	-	-	-	-	-	N/A -	N/A -
100 - 10000	155	Red	Cat. No.	150075	-	-	-	-	-	-	-	070945	
			Units/box	35	-	-	-	-	-	-	-	250	-
			Price/box	N/A -	-	-	-	-	-	-	-	N/A -	-

Tips not shown to scale. Refer to the lengths (in mm) in the table.

Protective filters

Protective filters to be inserted in the cone holder. The model "Plus" offers enhanced protection

Cat. No.	Description	Picus / Picus Nxt	Tacta	mLine	Proline plus	Proline	Units/ box	Price/ box
070797	Standard, Ø 2.51 mm, PE	725667, 070928, 725673, 725677, 070934, 070938	070985, 070986, 070992, 070995	070486, 070431, 070448, 070452	070839, 070918, 070840, 070846, 070849, 070853, 070854, 070855, 070856	070601, 070602, 070696, 070697, 070698	50	N/A -
070435	Standard, Ø 3.15 mm, PE	725668, 070929, 725674, 725678, 070935, 070939	070987, 070993, 070996	070432, 070449, 070453	070841, 070847, 070850, 070857	070603, 070604, 070700, 070701	50	N/A -
070436	Standard, Ø 5.33 mm, PE	725669, 070930, 725675, 725679, 070936, 070940	070988	070433	070842, 070858, 070859, 070860	070606, 070703, 070693, 070699	50	N/A -
070437	Standard, Ø 6.73 mm, PE	725670, 070931, 725671, 070932	070989, 070990	070434, 070833	070843, 070844, 070861, 070862, 070863	070608, 150064, 070707	50	N/A -
070444	Standard, Ø 1.83 mm, PE	-	-	-	-	070799, 070613, 070612, 070616	50	N/A -
070808	Plus, Ø 2.51 mm, PE	725667, 070928, 725673, 725677, 070934, 070938	070985, 070986, 070992, 070995	070486, 070431, 070448, 070452	070839, 070918, 070840, 070846, 070849, 070853, 070854, 070855, 070856	070601, 070602, 070696, 070697, 070698	50	N/A -
070438	Plus, Ø 3.15 mm, PE	725668, 070929, 725674, 725678, 070935, 070939	070987, 070993, 070996	070432, 070449, 070453	070841, 070847, 070850, 070857	070603, 070604, 070700, 070701	50	N/A -
070439	Plus, Ø 5.33 mm, PE	725669, 070930, 725675, 725679, 070936, 070940	070988	070433	070842, 070858, 070859, 070860	070606, 070703, 070693, 070699	50	N/A -
070440	Plus, Ø 6.73 mm, PE	725670, 070931, 725671, 070932	070989, 070990	070434, 070833	070843, 070844, 070861, 070862, 070863	070608, 150064, 070707	50	N/A -



Racks

Cat. No.	Description	Price
150068	Holder for 1 mechanical micropipette	N/A -
725620	2-sided linear rack	N/A -
070998	Carousel rack for 6 mechanical micropipettes	N/A -
150069	Adapter for mechanical carousel rack	N/A -
070773	Charging stand for 1 electronic micropipette	N/A -
070776	Carousel charging rack for 4 electronic micropipettes with adapter	N/A -



TIPS
MICROPIPETTES

Socorex micropipettes

Model	Acura® Dilute 810	Acura® manual 825	Acura® manual 835	Acura® manual 826XS	Acura® manual 855	Acura® Electro 926, 936 et 956
Operating mode	Manual	Manual	Manual	Manual	Manual	Electronic
Highlights	Straw tip, two volume dispensing for rapid sequential dilutions	Lightweight, robust, easy care	Lightweight, robust, easy care, optional pasteur pipette and straw adapter	Short, very light, robust, easy care	Lightweight, robust, 360° rotation of the bottom part, easy care	Intuitive programming, six working modes, fast charging, long autonomy
Volume range	1 ml and 0.1 ml	0.1 µl - 1 ml	0.2 µl - 10 ml	0.1 µl - 1 ml	0.5 µl - 350 µl	0.1 - 10000 µl
Available options	1-channel	1-channel	1-channel	1-channel	8 channel, 12 channel	27 adaptable volumetric modules
Autoclavable Parts	Entirely	Entirely	Entirely	Entirely	Entirely	Lower part

Micropipette Acura® Dilute 810



- ▶ Easy sampling in narrow containers thanks to the straw tip
- ▶ Dispensing without adjustment of 1 and 0.1 ml from a single pipetting with two pre-calibrated volumes
- ▶ Allows easy sequential dilution to 1:10
- ▶ Independent calibration of each volume
- ▶ Ergonomic shape, effortless pipetting
- ▶ Adjustable ejector
- ▶ Interchangeable PE protective filter
- ▶ Easy care and clean, autoclavable without disassembly

Cat. No.	Description	Units/bag	Units/box	Price/box
041120	Fixed volume sampling pipette Acura® 810	-	1	N/A -
041110	Sterile straw pipette 1.1 ml	25	1000	N/A -
041115	Sterile straw pipette 2.2 ml	25	1000	N/A -
061968	Replaceable PE protective filter	-	3600	N/A -

Micropipettes Acura® manual 825, 826XS, 855 and 835



- ▶ Lightweight, optimised grip and smooth piston activation
- ▶ Volume control with precision stop
- ▶ Rotating cap prevents accidental volume changes
- ▶ Fast and safe calibration by the user
- ▶ Autoclavable without disassembly
- ▶ Robust, shock and UV resistant
- ▶ Warranty: 3 years

Micropipette Acura® 825 and 826XS

- ▶ Acura® 826XS: shorter and lighter with a thinner bottom section to facilitate pipetting into microtubes

Volume (µl)	Increment (µl)	Suitable tips	Acura® 825		Acura® 826XS	
			Cat.No	Price	Cat.No	Price
0.1 - 2	0.002	10 µl	061104	N/A -	061700	N/A -
0.5 - 10	0.01	10 µl	061105	N/A -	061701	N/A -
1 - 10	0.01	200 µl	061106	N/A -	061702	N/A -
2 - 20	0.02	200 µl	061107	N/A -	061703	N/A -
5 - 50	0.1	200 µl	061108	N/A -	061704	N/A -
10 - 100	0.1	200 µl	061109	N/A -	061705	N/A -
20 - 200	0.2	200 and 350 µl	061110	N/A -	061706	N/A -
100 - 1000	1	1000 µl	061111	N/A -	061707	N/A -

Micropipettes Acura® manual 825, 826XS, 855 and 835 (continued)

Multichannel micropipettes Acura® 855

► Rotation of the bottom part through 360 °C

Volume (µl)	Increment (µl)	Suitable tips	8-channel		12-channel	
			Cat.No	Price	Cat.No	Price
0.5 - 10	0.01	10 µl	061132	N/A -	061135	N/A -
5 - 50	0.1	200 µl	061133	N/A -	061136	N/A -
10 - 100	0.1	200 µl	350370	N/A -	-	-
20 - 200	0.2	200 µl	061363	N/A -	061364	N/A -
40 - 350	0.4	350 µl	061134	N/A -	061137	N/A -

Macropipettes Acura® 835

► Pasteur pipettes or straw tips can be used on 2 and 5 ml models with the adapter

► Also available in fixed volume, find them on our website

Volume (µl)	Increment (µl)	Suitable tips	Cat.No	Price
200 - 2000	0.002	2 ml	061714	N/A -
200 - 2000	0.002	2 ml	350377*	N/A -
500 - 5000	0.01	5 ml	061112	N/A -
500 - 5000	0.01	5 ml	061200*	N/A -
1 - 10000	0.01	10 ml	061113	N/A -

Accessories for Acura® 835

Cat. No.	Description	Units/box	Price/box
061114	Protective filter for 2 and 5 ml models	250	N/A -
061115	Protective filter for 10 ml model	100	N/A -
061712	Straw adapter	1	N/A -
061259	Adapter for 2 ml Pasteur pipette	1	N/A -
061116	5 ml straw adapter for use with Pasteur pipette adapter	1	N/A -
061116	Sterile straw 5 ml	3600	N/A -



Acura® Manual Micropipette Kit

► TwiXS Kit Pack containing two Accura 826XS micropipettes

Cat. No.	Pipette 1	Pipette 2	Price
061708	0.1 - 2 µl	2 - 20 µl	N/A -
061709	0.5 - 10 µl	10 - 100 µl	N/A -
061789	2 - 20 µl	20 - 200 µl	N/A -
061710	5 - 50 µl	20 - 200 µl	N/A -
061711	10 - 100 µl	100 - 1000 µl	N/A -
061790	20 - 200 µl	100 - 1000 µl	N/A -

Supplied with:

- 1 shelf support;
- Qualitix tip samples;
- one QC certificate per pipette.

Trio Pack: set of 3 micropipettes Acura® Socorex

Cat. No.	Contents of the Trio Pack			Price
	Pipette 1	Pipette 2	Pipette 3	
061192	0.1 - 2 µl	0.5 - 10 µl	5 - 50 µl	N/A -
061194	0.1 - 2 µl	2 - 20 µl	20 - 200 µl	N/A -
061195	1 - 10 µl	5 - 50 µl	20 - 200 µl	N/A -
061367	0.5 - 10 µl	10 - 100 µl	100 - 1000 µl	N/A -
061196	1 - 10 µl	10 - 100 µl	100 - 1000 µl	N/A -
061197	2 - 20 µl	20 - 200 µl	100 - 1000 µl	N/A -
061366	5 - 50 µl	20 - 200 µl	100 - 1000 µl	N/A -
061198	10 - 100 µl	100 - 1000 µl	0.5 - 5 ml	N/A -
061199	100 - 1000 µl	0.5 - 5 ml	1 - 10 ml	N/A -

► TrioPack containing 3 micropipettes 825 (volume 0.1 to 1000 µl) or Macropipettes 835 (volume 0.2 to 10 ml)

► Supplied with Qualitix tip samples and QC certificate per pipette



TIPS
MICROPIPETTES

Electronic micropipettes Acura® Electro 926 micro, 936 macro, 956 multi Socorex



- Light
- Intuitive programming
- Six pipetting modes "direct", "reverse", "multidistribution", "dilution", "touch" and "mix"
- Pipetting cycle counter
- Clear display, right/left-handed reversible reading
- Interchangeable battery
- Many autoclavable and interchangeable volumetric modules available, please consult us
- Adjustment of the ejection height
- Fast charge, long autonomy (3000 cycles)

Volume (µl)	Division (µl)	Tip Type	Acura® Electro Basic set		Micropipette Acura® Electro*	
			Cat.No	Price	Cat.No	Price

Micropipettes Acura® Electro XS 926

0.1 - 2	0.01	Ultra 10 µl	061728	N/A -	061720	N/A -
0.5 - 10	0.05	Ultra 10 µl	061729	N/A -	061721	N/A -
0.5 - 10	0.05	200 µl	061730	N/A -	061722	N/A -
1 - 20	0.1	200 µl	061731	N/A -	061723	N/A -
2.5 - 50	0.25	200 µl	061732	N/A -	061724	N/A -
5 - 100	0.5	200 µl	061733	N/A -	061725	N/A -
10 - 200	1.0	200 µl	061734	N/A -	061726	N/A -
50 - 1000	5	1000 µl	061735	N/A -	061727	N/A -

Macropipettes Acura® Electro 936

0.1 - 2 ml	0.01 ml	2 ml	061739	N/A -	061736	N/A -
0.25 - 5 ml	0.05 ml	5 ml	061740	N/A -	061737	N/A -
0.5 - 10 ml	0.05 ml	10 ml	061741	N/A -	061738	N/A -

Multichannel 8-channel Acura® Electro 956

0.5 - 10	0.05	Ultra 10 µl	061750	N/A -	061742	N/A -
2.5 - 50	0.25	200 µl	061751	N/A -	061743	N/A -
10 - 200	1	200 µl	061752	N/A -	061744	N/A -
20 - 350	5	350 µl	061753	N/A -	061745	N/A -

Multichannel 12-channel Acura® Electro 956

0.5 - 10	0.05	Ultra 10 µl	061754	N/A -	061746	N/A -
2.5 - 50	0.25	200 µl	061755	N/A -	061747	N/A -
10 - 200	1.0	200 µl	061756	N/A -	061748	N/A -
20 - 350	5.0	350 µl	061757	N/A -	061749	N/A -

* Supplied without charger: to be completed with the charging carousel Cat. No. 061150 and the charger Cat. No.061154.

7 micropipettes (0.1 to 1000 µl), 3 macropipettes (0.1 to 10 ml) and 8 multichannel (0.1 to 350 µl).

2 presentations:

- The Acura® Electro micropipette is supplied individually with the calibration certificate, Qualitips® sample tips, instructions for use, without charger*;
- a basic set includes:
 - one pipette,
 - an individual calibration certificate,
 - instructions for use,
 - a charging stand,
 - an extra battery pack,
 - a power socket,
 - Qualitips® sample tips.

Socorex Qualix® Tips

- Premium quality polypropylene, free of heavy metals and cytotoxic elements
- Certified protease-free filter tips

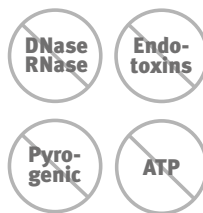

Socorex Qualix® Standard tips

Volume (µl)	Type	Length (mm)	Graduation	Colour	Auto-clavable	Type	Sterile	Bulk			On a rack			Refill		
								Cat.No	Units/box	Price/box	Cat.No	Units/box	Price/box	Cat.No	Units/box	Price/box
10	Thin shaft	31.4	No	Natural	Yes	Standard	No	985206	1000	N/A -	985207	12 x 96	N/A -	985208	13 x 96	N/A -
						Standard	Yes	-	-	-	985210	12 x 96	N/A -	-	-	-
						Low Binding	No	-	-	-	985212	12 x 96	N/A -	-	-	-
		Low Binding	Yes	-		-	-	985213	12 x 96	N/A -	-	-	-			
		Standard	No	985214		1000	N/A -	985215	10 x 96	N/A -	-	-	-			
		Low Binding	No	-		-	-	985217	10 x 96	N/A -	-	-	-			
200	Bevelled	49.6	Yes	Natural	Yes	Standard	No	985221	1000	N/A -	985222	10 x 96	N/A -	985223	10 x 96	N/A -
						Standard	Yes	-	-	-	985224	10 x 96	N/A -	-	-	-
						Low Binding	No	-	-	-	985226	10 x 96	N/A -	-	-	-
			Low Binding	Yes		-	-	-	985227	10 x 96	N/A -	-	-	-		
			Standard	No		985228	1000	N/A -	985229	10 x 96	N/A -	-	-	-		
			Standard	Yes		-	-	-	985230	10 x 96	N/A -	-	-	-		
350	Thin shaft	58.8	No	Natural	No	Standard	No	350265	1000	N/A -	061941	10 x 96	N/A -	-	-	
1000	Thin shaft	88.9	No	Natural		Standard	No	985233	1000	N/A -	985234	6 x 96	N/A -	-	-	
						Standard	Yes	-	-	-	985237	6 x 96	N/A -	-	-	
						Low Binding	No	-	-	-	985239	6 x 96	N/A -	-	-	
						Low Binding	Yes	-	-	-	985240	6 x 96	N/A -	-	-	
2000	Bevelled	75.9	No	Blue		Standard	No	985241	1000	N/A -	985242	6 x 96	N/A -	-	-	
					Standard	Yes	-	-	-	985243	6 x 96	N/A -	-	-		
			Yes	Natural	Standard	No	985244	1000	N/A -	985245	6 x 96	N/A -	-	-		
				Natural	Standard	No	061689	500	N/A -	-	-	-	-			
5000	Macro	123.2	Yes	Natural	Standard	No	061698	500	N/A -	061699	2 x 50	N/A -	-	-		
10000	Macro	150	No	Natural	Standard	No	061155	300	N/A -	-	-	-	-			

Socorex Qualix® filter tips - on rack



Vol. (µl)	Type	Length (mm)	Graduation	Colour	Cat.No	Units/box	Price/box
10	Thin shaft	31.4	Yes	Natural	985211	12 x 96	N/A -
		38.1	No	Natural	985211	12 x 96	N/A -
20	Bevelled	49.6	No	Natural	985219	10 x 96	N/A -
100	Bevelled	49.6	No	Natural	985220	10 x 96	N/A -
200	Bevelled	51.2	No	Natural	985225	10 x 96	N/A -
1000	Thin shaft	88.9	No	Natural	985238	6 x 96	N/A -

Empty racks

Cat. No.	Description	Units/box	Price/box
985209	Autoclavable empty rack for 96 x 10 and 200 µl tips	10	N/A -
985236	Autoclavable Empty rack for 96 x 1000 µl tip	6	N/A -
350270	Autoclavable empty rack for 24 x 10 ml tips	4	N/A -

* Can be used with charging systems.

**TIPS
MICROPIPETTES**

Smartie coloured caps



Cat. No.	Colour	Price 6 units	Cat. No.	Colour	Price 6 units	Cat. No.	Colour	Price 6 units
061117	White	N/A -	061122	Orange	N/A -	061127	Ice Blue	N/A -
061118	Gray	N/A -	061123	Red	N/A -	061128	Blue	N/A -
061119	Vanilla	N/A -	061124	Pink	N/A -	061129	Mint	N/A -
061120	Lime	N/A -	061125	Fuchsia	N/A -	061130	Green	N/A -
061121	Yellow	N/A -	061126	Violet	N/A -	061131*	Assorted colors	N/A -

* price for 14

Universal holder for 7 micropipettes



For single-channel, manual and electronic Socorex models. And for additional volumetric modules.

Cat. No.	Colour	Price
061005	Light grey	N/A -
061006	Vanilla	N/A -
061007	Ice Blue	N/A -
061008	Mint	N/A -
061365	Pink	N/A -

Universal twister rack for 6 pipettes



- For 6 pipettes of all brands
- Easy rotation of the entire rack by rotating the base with the finger
- Very stable
- Anti-slip pads
- 7 bright, translucent colours
- The coloured holders can be removed from the holder and cleaned easily with water and detergent

Sapphire Blue	Emerald Green	Topaz Orange	Quartz Grey	Ruby Red	Transp. Diamond	Yellow Citrine	Price
061791	061792	061793	061794	061795	061796	061797	N/A -

Socorex Holder for 3 pipettes



Stand designed for 3 multi-channel and single-channel pipettes. Allows for a perfect fit and easy grip of each instrument. For all Calibra® and Acura® models.

- Good stability on the bench
- Non-slip feet
- Robust polyamide, easy to clean

Cat.No	Description	Price
061257	Holder for 3 pipettes	N/A -

Polycarbonate shelf holder



- Storage of two micropipettes Acura® manual, Calibra® digital and Acura® self-refill 865
- Fixing with self-adhesive tape

Cat. No.	Description	Price
061692	Adhesive holder for two micropipettes	N/A -

Ecopipette Micropipettes

- Large tip ejection button
- Fully autoclavable without disassembly
- Metal base
- Double seal for better sealing

Cat. No.	Volume (µl)	Colour code	Price
091037	0.2 - 2	Violet	N/A -
091038	0.5 - 10	White	N/A -
091039	2 - 20	Grey	N/A -
091040	5 - 50	Red	N/A -
091041	10 - 100	Orange	N/A -
091042	20 - 200	Yellow	N/A -
091043	100 - 1000	Blue	N/A -



Rack for 3 pipettes

Cat. No.	Description	Price
091176	PRack for 3 pipettes Capp	N/A -

Bravo variable volume micropipettes

- Fully autoclavable
- Ergonomic
- Ultra-light

Cat. No.	Volume (µl)	Colour code	Price
091186	0.2 - 2	Pink	N/A -
091187	0.5 - 10	Grey	N/A -
091189	2 - 20	Grey	N/A -
091190	5 - 50	Red	N/A -
091191	10 - 100	Orange	N/A -
091192	20 - 200	Yellow	N/A -
091193	100 - 1000	Blue	N/A -
091194	1 - 5000	Green	N/A -
091195	1 - 10000	Green	N/A -



Micropipettes CappAero 8, 12, 16, 48, 64 channel

- Fixed and variable volumes combined in one micropipette
- Volume can be changed and locked with one hand
- Suitable for right and left handed people
- Fully autoclavable, easy care and maintenance
- Simple ejection system
- Ergonomic design allows easy maintenance, quick access to pistons for cleaning and lubrication
- Double seal on each cone holder for better adaptability of the tips
- Robustness and chemical resistance thanks to anodised aluminium, stainless steel and durable plastics
- Each channel is independent
- 3 year warranty on all CappAero pipettors

Volume (µl)	Code Colour	8-channel		12-channel	
		Cat. No.	Price	Cat. No.	Price
0.5 - 10 µl	White	091206	N/A -	091212	N/A -
2 - 20 µl	Grey	091207	N/A -	091213	N/A -
5 - 50 µl	Red	091208	N/A -	-	-
10 - 100 µl	Orange	091209	N/A -	091214	N/A -
20 - 200 µl	Yellow	091210	N/A -	091215	N/A -
30 - 300 µl	Black	091211	N/A -	091216	N/A -



CappAero Softline 16-channel micropipettes

Cat. No.	Channel Number	Volume (µl)	Colour	Price
091018	16	0.2 - 2	Violet	N/A -
091017	16	0.5 - 10	White	N/A -
091035	16	5 - 50	Red	N/A -

CappAero 48 channel micropipettes (standard handle)

Cat. No.	Description	Price
091096	48 channel standard pipette 0.5 - 10 µl	N/A -
091090	EXPELLPLUS Tips 0.2 - 50 µl Capp (10 units of 384)	N/A -

CappAero accessories

Cat. No.	Description	Price
091019	Carousel rack for 6 single or 3 multi-channel CappAero	N/A -

CAPP Microbiology Micropipette

- To be used with straw tips
- For volumes of 100, 900 and 1000 µl
- Comes with the 3 buttons of the 3 volumes
- Ideal for pipetting viscous products such as cream, yoghurt, cosmetics
- Free rotation of the volume
- Fully autoclavable

Sterile straws

Cat. No.	Description	Price
091076	Sterile straws, 19 cm	N/A -



Cat. No.	Description	Price
091009	Microbiology pipette volume 100, 900 or 1000 µl	N/A -

Transferpette S Micropipettes



- ▶ Short-stroke piston with reduced pipetting force
- ▶ Volume lock for safe pipetting
- ▶ Colour coding visible on the display, the locking button and the bottom of the micropipette
- ▶ Quick and tool-free calibration with Easy Calibration technology
- ▶ Fine tip holder for easy pipetting in narrow containers
- ▶ Autoclavable at 121 °C without disassembly

Transferpette S Micropipette, variable volume

Cat. No.	Volume (µl)	Colour code	Price
042527	0.1 - 1	Grey (nano-cap)	N/A -
042528	0.1 - 2.5	Grey (nano-cap)	N/A -
042529	0.5 - 10	Grey	N/A -
042530	2 - 20	Yellow	N/A -
042531	5 - 50	Yellow	N/A -
042532	10 - 100	Yellow	N/A -
042533	20 - 200	Yellow	N/A -
042534	100 - 1000	Blue	N/A -
042535	500 - 5000	Red	N/A -
042536	1000 - 10000	Light blue	N/A -

Transferpette S Micropipette, fixed volume

Cat. No.	Volume (µl)	Colour code	Price
042518	10	Grey	N/A -
042519	20	Yellow	N/A -
042520	25	Yellow	N/A -
042521	50	Yellow	N/A -
042522	100	Yellow	N/A -
042523	200	Yellow	N/A -
042524	500	Blue	N/A -
042525	1000	Blue	N/A -
042526	2000	Red	N/A -

Transferpette S multichannel micropipettes

Volume (µl)	Colour code	Model 8-channel		Model 12-channel	
		Cat.No	Price	Cat.No	Price
0.5 - 10	Grey	042543	N/A -	042548	N/A -
5 - 50	Yellow	042544	N/A -	042549	N/A -
10 - 100	Yellow	042545	N/A -	042550	N/A -
20 - 200	Yellow	042546	N/A -	042551	N/A -
30 - 300	Green	042547	N/A -	042552	N/A -



BRAND Electronic Transferpette Micropipettes



- ▶ Reduced attachment and ejection forces
- ▶ Adjustable retaining strap
- ▶ Intuitive menu control
- ▶ Program selections: pipetting, reverse pipetting, mixing, gel electrophoresis, dispensing, Easy Calibration technique
- ▶ 4000 pipetting cycles for one battery charge
- ▶ Can be used while recharging
- ▶ Autoclavable lower part

Transferpette Electronic Micropipettes, single channel

Volume (µl)	Increment (µl)	Colour code	Cat. No.	Price
0.5 - 10	0.01	Grey	042583	N/A -
2 - 20	0.02	Grey	781974	N/A -
10 - 200	0.2	Yellow	781605	N/A -
50 - 1000	1	Blue	781731	N/A -
250 - 5000	5	Red	674097	N/A -

Transferpette Electronic Micropipettes, multi-channel

Volume (µl)	Increment (µl)	Colour code	8-channel		12-channel	
			Cat.No	Price	Cat.No	Price
0.5 - 10	0.01	Grey	042584	N/A -	781977	N/A -
1 - 20	0.02	Grey	781975	N/A -	781978	N/A -
5 - 100	0.1	Yellow	781616	N/A -	781979	N/A -
10 - 200	0.2	Yellow	674385	N/A -	781980	N/A -
15 - 300	0.5	Green	674375	N/A -	042585	N/A -

Accessories

Cat. No.	Description	Price
781981	Refill holder for 3 electronic Transferpette Pipettes	N/A -
781982	Individual holder for 1 Electronic Transferpette Pipette	N/A -
781984	Individual holder for Transferpette Multi-channel Pipettes	N/A -

Brand Tips

- Scaled for quick volume control
- All racked tips up to 1000 µl are free of DNA, RNase, endotoxins and ATP
- Autoclavable up to 121 °C
- Marking CE IVD 98/79 CE



Non-filter Tips

Vol. (µl)	Colour code	Bulk			Rack			Sterile rack			Refill trays		
		Cat.No	Units/box	Price/box	Cat.No	Units/box	Price/box	Cat.No	Units/box	Price/box	Cat.No	Units/box	Price/box
0.1 - 20	Grey (nano-cap)	092452	1000	N/A -	042554	5 x 96	N/A -	092460	10 x 96	N/A -	-	-	-
0.5 - 20	Grey	092453	1000	N/A -	781739	5 x 96	N/A -	092461	10 x 96	N/A -	674389	10 x 96	N/A -
1 - 50	Grey	-	-	-	042555	5 x 96	N/A -	042557	10 x 96	N/A -	-	-	-
2 - 200	Yellow	092454	1000	N/A -	781740	5 x 96	N/A -	092462	10 x 96	N/A -	674390	10 x 96	N/A -
5 - 300	Green	092455	1000	N/A -	042556	5 x 96	N/A -	092463	10 x 96	N/A -	-	-	-
50 - 1000	Blue	092456B	5000	N/A -	781741	5 x 96	N/A -	092464	10 x 96	N/A -	674391	10 x 96	N/A -
500 - 5000	Red	092458	200	N/A -	781609	1 x 28	N/A -	-	-	-	-	-	-
1000 - 10000	Light blue	092459	200	N/A -	781612	1 x 18	N/A -	-	-	-	-	-	-

Filter tips

Vol. (µl)	Colour code	Standard						Ultra Low Retention		
		Sterile rack			Sterile refill			Sterile rack		
		Cat.No	Units/box	Price/box	Cat.No	Units/box	Price/box	Cat.No	Units/box	Price/box
0.1 - 1	Grey (nano-cap)	042558	10 x 96	N/A -	042560	10 x 96	N/A -	042567	10 x 96	N/A -
0.5 - 10	Grey	674378	10 x 96	N/A -	042561	10 x 96	N/A -	042568	10 x 96	N/A -
1 - 20	Grey	042559	10 x 96	N/A -	042562	10 x 96	N/A -	042569	10 x 96	N/A -
2 - 20	Yellow	674379	10 x 96	N/A -	042563	10 x 96	N/A -	042570	10 x 96	N/A -
5 - 100	Yellow	781636	10 x 96	N/A -	042564	10 x 96	N/A -	042571	10 x 96	N/A -
5 - 200	Yellow	674380	10 x 96	N/A -	042565	10 x 96	N/A -	042572	10 x 96	N/A -
50 - 1000	Red	091468	10 x 96	N/A -	042566	10 x 96	N/A -	042573	10 x 96	N/A -



ClearLine® Micropipettes



- ▶ Light weight and soft spring system for comfortable working
- ▶ Adjusting the height of the ejection system
- ▶ Volume range
- ▶ Fully autoclavable
- ▶ Resistant to UV

ClearLine® single-channel micropipettes

Volume (µl)	Colour code	Cat. No.	Price	Cat. No. Cofrac certified*	Price
0.1 - 2	Red	257029	N/A -	257029C	N/A -
0.5 - 10	Red	257030	N/A -	257030C	N/A -
2 - 20	Yellow	257031	N/A -	257031C	N/A -
10 - 100	Yellow	257032	N/A -	257032C	N/A -
20 - 200	Yellow	257033	N/A -	257033C	N/A -
100 - 1000	Blue	257034	N/A -	257034C	N/A -
500 - 5000	White	257035	N/A -	257035C	N/A -
1000 - 10000	White	257036	N/A -	257036C	N/A -

ClearLine® multichannel Micropipettes

Volume (µl)	Colour code	8-channel				12-channel			
		Cat.No	Price	Cat. No. Cofrac certified*	Price	Cat.No	Price	Cat. No. Cofrac certified*	Price
1 - 10	Red	257037	N/A -	257037C	N/A -	257041	N/A -	257041C	N/A -
0.5 - 10	Yellow	257038	N/A -	257038C	N/A -	257042	N/A -	257042C	N/A -
20 - 200	Yellow	257039	N/A -	257039C	N/A -	257043	N/A -	257043C	N/A -
50 - 300	Green	257040	N/A -	257040C	N/A -	257044	N/A -	257044C	N/A -

* Cofrac certified micropipettes (3 volumes, 10 weighings) delivered with certificate.

ClearLine® Filtered and non-filtered tips



The ultimate solution for liquid samples.

- ▶ **Filter and non-filter tips** made of transparent polypropylene on a rack with a covering lid or on a hinged rack
- ▶ **ISO-8655:** the ISO-8655 standard established by an independent laboratory guarantees that the pipette tips used do not alter the technical specifications of precision and reproducibility given by the manufacturer. 2 surface options: **standard** or **low binding**
- ▶ **2 Racks to choose from:**
 - ClearLine® Rack: rack with covering lid
 - ClearLine® Plus Rack: hinged lid rack, stackable and colour-coded
- ▶ **Compatible with all brands of micropipettes**

ISO-8655 certification

ClearLine® Racked non-filter tips - universal compatibility

Photo No***	Vol. (µl)	Description	Units/box	On ClearLine® rack				On ClearLine® Plus rack			Refill for rack ClearLine® Plus
				Standard tips		Low binding Tips		Standard tips		Low binding Tips	Standard tips
				No sterile	Sterile	No sterile	Sterile	No sterile	Sterile	Sterile	No sterile
4	10	Long fine tip 45 mm	10 x 96	030560ACL	030570ACL	-	-	713245	713246	713247	-
3	10	Long tip 45 mm	10 x 96	037640CL	037660CL	037640TCL	037660TCL	713275	713276	713277	713268
7	200	Natural Tip - length 50.7 mm	10 x 96	032230CL	032250CL	-	035100ACL	713248	713249	713250	713269
7	200	Yellow Tip- length 50.7 mm	10 x 96	032240CL	032260CL	-	-	-	-	-	-
-	300	Universal tip - length 59 mm	10 x 96	-	-	-	-	713251	713252	713253	713270
10	1000	Blue Tip - length 72.8 mm	10 x 100	027110CL	027120CL	-	-	-	-	-	-
11	1250	Long tip 102 mm	8 x 96	134750CL*	134760CL*	-	-	713254	713255	-	713271
Price/box				N/A -	N/A -	N/A -	N/A -	N/A -	N/A -	N/A -	N/A -

* On a hinged rack

** See photo of model with filter (next page) - not including this one

ClearLine® Filter and non-filter tips (continued)



ClearLine® Filter tips, sterile, on rack

Photo number	Volume (µl)	Description	Compatibility	On ClearLine® rack						On ClearLine® Plus rack		
				Standard Tips			Low binding Tips			Low binding Tips		
				Cat.No	Pack unit.	Price	Cat.No	Pack unit.	Price	Cat.No	Pack unit.	Price
1	0.1 - 10	Gilson short tip length 28.8 mm	Universal	028200CL	10 x 96	N/A -	035200CL	10 x 96	N/A -	-	-	-
2	0.5-10	Eppendorf long tip length 45.5 mm	Eppendorf, Socorex, Gilson, Rainin	015020CL	10 x 96	N/A -	035210CL	10 x 96	N/A -	-	-	-
3	0.1 - 10	Long tip 45 mm	Universal	038000CL	10 x 96	N/A -	038000TCL	10 x 96	N/A -	713278	10 x 96	N/A -
4	0.1 - 10	Long fine point 45 mm	Universal	130340CL	10 x 96	N/A -	-	-	-	713260	10 x 96	N/A -
5	1 - 20	Universal tip - length 50.7 mm	Universal	014210CL	10 x 96	N/A -	035220CL	10 x 96	N/A -	713261	10 x 96	N/A -
6	1 - 100	Universal tip - length 50.7 mm	Universal	036060CL	10 x 96	N/A -	036060TCL	10 x 96	N/A -	713262	10 x 96	N/A -
7	1 - 200	Universal tip - length 50.7 mm	Universal	014220CL	10 x 96	N/A -	035230CL	10 x 96	N/A -	713263	10 x 96	N/A -
8	20 -200	Polyvalent tip for 20, 100 or 200 µl micropipette - length 78 mm	Universal	017370CL	10 x 96	N/A -	035240CL	10 x 96	N/A -	713264	8 x 96	N/A -
9	1 - 300	Long tip 78 mm	Universal	130510CL	10 x 96	N/A -	130510TCL	10 x 96	N/A -	713265	8 x 96	N/A -
10	100-1000	Universal tip - length 72.8 mm	Universal	014200CL	10 x 100	N/A -	035260CL	10 x 100	N/A -	-	-	-
11	50-1250	Long tip 102 mm	Universal	134000CL*	8 x 96	N/A -	-	-	-	713266	8 x 96	N/A -

NB: Photos are not to scale
* On hinged rack

Accessories

Cat. No.	Description	Price
713257	Empty box for refill ClearLine® Plus 10, 200 and 300 µl	N/A -
713258	Empty box for refill ClearLine® Plus 1000 and 1250 µl	N/A -

TIPS
MICROPIPETTES

Filter and non-filter tips on hinged rack ClearLine®



- Sterile Tips with or without filter
- Filter tips, low binding: maximum sample recovery ensuring accurate dispensing of the volume dispensed
- Universal compatibility

Human DNA

DNase RNase

Endotoxins

Pyrogenic

PCR-inhibitor

CE

CE / IVD / ISO-8655 certification

IVD

ClearLine® Sterile filter tips on hinged rack

Vol. (µl)	Description	Tray colour	Pack unit.	Cat.No	Price	Filter tip, sterile, low binding
10	10 µl graduated tip length: 31.24 mm	Red	10 x 96	713130	N/A -	
10	10 µl long graduated tip length: 45.87 mm	Red	10 x 96	713114	N/A -	
20	20 µl graduated tip length: 50.75 mm	Yellow	10 x 96	713115	N/A -	
100	100 µl graduated tip length: 59.54 mm	Yellow	10 x 96	713116	N/A -	
200	200 µl graduated tip length: 59.54 mm	Yellow	10 x 96	713117	N/A -	
300	300 µl graduated tip Length: 59.54 mm	Green	10 x 96	713131	N/A -	
1000	1000 µl graduated tip length: 81.78 mm	Blue	8 x 96	713118	N/A -	
1250	1000µl long graduated tip length: 98.40 mm	Blue	8 x 96	713119	N/A -	

ClearLine® Sterile non-filter tips on hinged rack

Vol. (µl)	Description	Tray colour	Pack unit.	Cat.No	Price	Cat.No	Price	Non-filter tip, sterile, standard	Non-filter tip, stérile, low binding
10	10 µl graduated tip length: 31.24 mm	Red	10 x 96	713136	N/A -	713142	N/A -		
10	10 µl long graduated tip length: 45.84 mm	Red	10 x 96	713135	N/A -	713141	N/A -		
-	-	-	-	-	-	-	-		
-	-	-	-	-	-	-	-		
200	200 µl graduated tip length: 50.75 mm	Yellow	10 x 96	713137	N/A -	713143	N/A -		
300	300 µl graduated tip Length: 59.54 mm	Green	10 x 96	713138	N/A -	713144	N/A -		
1000	1000 µl graduated tip length: 83.09 mm	Blue	8 x 96	713139	N/A -	713145	N/A -		
1250	1000µl long graduated tip length: 98.40 mm	Blue	8 x 96	713140	N/A -	713146	N/A -		

TIPS MICROPIPETTES

ClearLine® hinged rack charging system

- Simple and fast charging system
- Standard or low binding tips, non-sterile, no filter, universal compatibility
- Ecological: cardboard packaging (reduction of plastic waste linked to the packaging of refill towers)
- Very small footprint: system requires 57% less storage space than other systems
- ClearLine® refill trays are compatible with ClearLine® hinged filter tip racks
- Available in Cleanpack resealable bags

Human
DNA

DNase
RNase

Endo-
toxins

Pyro-
genic

PCR-
inhibitor

CE

IVD

CE / IVD / ISO-8655 certification



Volume (µl)	Description	Tray colour	Standard tip refill						Low binding tip refill					
			Cardboard support			Cleanpack bag			Cardboard support			Cleanpack bag		
			Cat.No	Pack unit.	Price	Cat.No	Pack unit.	Price	Cat.No	Pack unit.	Price	Cat.No	Pack unit.	Price
10	10 µl graduated tip length: 31.24 mm	Red	713128	10 x 96	N/A -	713165	5 x 960	N/A -	713151	10 x 96	N/A -	713172	5 x 960	N/A -
10	10 µl long graduated tip, length: 45.84 mm	Red	713110	10 x 96	N/A -	713166	5 x 960	N/A -	713147	10 x 96	N/A -	713173	5 x 960	N/A -
-	-	-	-	-	-	-	-	-	-	-	-	-	-	-
-	-	-	-	-	-	-	-	-	-	-	-	-	-	-
200	200 µl graduated tip length: 50.75 mm	Yellow	713111	10 x 96	N/A -	713167	5 x 960	N/A -	713148	10 x 96	N/A -	713174	5 x 960	N/A -
300	300 µl graduated tip Length: 59.54 mm	Green	713129	10 x 96	N/A -	713168	5 x 960	N/A -	713162	10 x 96	N/A -	713175	5 x 960	N/A -
1000	1000 µl graduated tip length: 81.78 mm	Blue	713112	8 x 96	N/A -	713169	4 x 960	N/A -	713149	8 x 96	N/A -	713176	4 x 960	N/A -
1250	1000 µl long graduated tip length: 98.40 mm	Blue	713113	8 x 96	N/A -	713170	4 x 960	N/A -	713150	8 x 96	N/A -	713177	4 x 960	N/A -

NB: Photos are not to scale

Empty boxes for ClearLine® refill system



Cat. No.	Description	Units/box	Price/box
713120	Empty box for 10 µl tips to 300 µl ClearLine®	10	N/A -
713121	Empty box for 1000 µl and 1250 µl tips ClearLine®	8	N/A -



TIPS MICROPIPETTES

LabMate Pro micropipettes



- > One-handed volume control
- > Low pipetting effort
- > Strong tip holder
- > Adjustment of the height of the ejection system with small pins
- > Fully autoclavable
- > Resistant to UV
- > Stainless steel ejector
- > Easy maintenance and recalibration

		LabMate Pro single channel	
Volume (µl)	Type	Cat.No	Price
0.1 - 2	LMPP2	060800B	N/A -
0.5 - 10	LMP10	060801B	N/A -
2 - 20	LMP20	060802B	N/A -
5 - 50	LMP50	060803B	N/A -
10 - 100	LMP100	060804B	N/A -
20 - 200	LMP200	060805B	N/A -
50 - 250	LMP250	060806B	N/A -
100 - 1000	LMP1000	060807B	N/A -
1000 - 5000	LMP5000	060808B	N/A -
1000 - 10000	LMP10000	060809B	N/A -

Racks

Cat. No.	Description	Price
060838	Universal plexiglas pipette holder	N/A -
060839	Universal plexiglass 4 pipette holder	N/A -
060829	Carousel stand, 6 places grey	N/A -

HP®pette High precision micropipettes

- > Mechanical air displacement pipettes, volume range 0.5 µl to 5 ml
- > Good handling, easy to use
- > Volume readout window visible on the side of the pipette, ejector button on the back for easy ejection
- > Fully autoclavable

Supplied with: calibration key, operating instructions, grease tube, pipette holder, performance certificate to ISO8655/ DIN12650



HP®pette Single channel Micropipettes, variable volume

Cat. No.	Volume (µl)	Increment	Price
861036VA	0.1 - 2.5	0.05 µl	N/A -
861037VA	0.5 - 10	0.1 µl	N/A -
861038VA	2 - 20	0.5 µl	N/A -
861039VA	5 - 50	0.5 µl	N/A -
861040VA	10 - 100	1 µl	N/A -
861041VA	20 - 200	1 µl	N/A -
861042VA	50 - 200	1 µl	N/A -
861043VA	100 - 1000	5 µl	N/A -
861045VA	200 - 1000	5 µl	N/A -
861044VA	1000 - 5000	50 µl	N/A -

HP®pette Singles channel Micropipettes, fixed volume

Cat. No.	Volume (µl)	Price
861026VA	5	11N/A -
861027VA	10	11N/A -
861029VA	20	11N/A -
861028VA	20	11N/A -
861030VA	50	11N/A -
861031VA	100	11N/A -
861034VA	200	11N/A -
861032VA	250	11N/A -
861033VA	500	11N/A -
861035VA	1000	11N/A -

HP®pette 8-channel Micropipettes, variable volume

Cat. No.	Volume (µl)	Increment (µl)	Price
861046VA	0.5-10	0.1	N/A -
861047VA	5-50	0.5	N/A -
861048VA	50-300	5	N/A -

Minifix micropipette



- > Economical micropipette guaranteed for up to 5000 pipettings
- > Fixed volume, colour coded on the push button
- > Total length 13 cm, extremely light (10 g)
- > Blister-packed
- > Re-calibration possible

Cat.No	Minifix Model	Recommended tip	Price
391187	Minifix 5 µl	Micro Gilson / Eppendorf o. - 10 µl	N/A -
391188	Minifix 10 µl	Universal tip 20 -200 µl	N/A -
391189	Minifix 20 µl	Universal tip 20 -200 µl	N/A -
391190	Minifix 25 µl	Universal tip 20 -200 µl	N/A -
391191	Minifix 50 µl	Universal tip 20 -200 µl	N/A -
391192	Minifix 100 µl	Universal tip 20 -200 µl	N/A -

Multi One Touch bi-component non-filter and filter tips

- > Two-component tips: upper part in soft elastomer
- > Optimal tightness and precision: ideal tips for multi-channel pipetting
- > Reduced muscle fatigue for the user



One Touch bi-component tips

Tip	Plastic rack		
	Cat.No	Units/box	Price/box
20 µl non sterile	010300	10 x 96	N/A -
20 µl sterile	010310	10 x 96	N/A -
330 µl non sterile	010330	10 x 96	N/A -
330 µl sterile	010340	10 x 96	N/A -
1000 µl non sterile	010360	8 x 96	N/A -
1000 µl sterile	010370	8 x 96	N/A -

One Touch bi-component filter tips

Volume (µl)	Plastic Cell-Rack		
	Cat.No	Units/box	Price/box
1 - 20	010320	10 x 96	N/A -
10 - 100	010510	10 x 96	N/A -
20 - 350	010350	10 x 96	N/A -
100 - 1250	010380	8 x 96	N/A -

Multi Tips

> A guarantee of quality



> Advantages

- A tip especially designed for research
- A graSoft Tip: made of a softer polypropylene, these tips make it easier to attach to the micropipette and reduce the effort.
- A wide range of packaging and presentation options - see below.

> Standard tip or Low Binding tip

Multi tips offer two surface qualities:

- the "standard" surface in virgin polypropylene;
- the "Low Binding" surface: the tip, made hydrophobic, reduces surface tensions. This property has two advantages: maximum sample recovery and much lower DNA and protein retention than with an ordinary tip.

All Cat. No.: Next pages

Multi Tips, bulk



In a bag with a zip to guarantee re-sealing.

Hinged rack



Rack with hinged lid, hinge and lock.

CellRack Racked tips



- > Rack with hinged or covering lid
- > Individual closed cells for each tip
- > Design eliminates the risk of tip-to-tip contamination
- > Easy insertion of the tips on the micropipette
- > Enhanced rack stability
- > Autoclavable

Refill tips on Platinum tray

- > Sturdy pyramid hinged rack, stackable, repeatedly autoclavable
- > Saves space and waste
- > Transparent packaging to allow visualization of the tips



Refill Tips on QuickRack



- > 96 tips on a tray
- > Simply take a tray and place it on any empty tip rack to have a loaded rack
- > Fast, economical, small footprint
- > Allows reuse of empty Cell Rack

TipStation racked Tips



- > 10 ready-to-use tip racks in a minimum of space
- > Simply remove one level after using the tips
- > High stability bottom
- > Ideal for multi-channel micropipettes
- > Two-compartment lid

TIPS
MICROPIPETTES

Multi Tips



Bulk

See the racks description on the next page

Tips	Vol. (µl)	Model	Length (mm)	Ø opening (mm)	Graduation (µl)	Colour	Type	Sterile	Cat.No	Units/box	Price/box						
	10	10 µl Sharp	44.83	0.36	1, 2, 5, 10	Natural	Standard	No	-	-	-						
							Standard	Yes	-	-	-						
	10	10 µl E (Eppendorf compatible)	45.5	0.38	-	Natural	Standard	No	013970	1000	N/A -						
							Standard	Yes	-	-	-						
							Low binding	No	035040A	1000	N/A -						
							Low binding	Yes	-	-	-						
							Standard	No	023580A	1000	N/A -						
	10	10 µl Ultra G (Gilson compatible)	28.8	0.38	2, 10	Natural	Standard	Yes	-	-	-						
							Low binding	No	035000A	1000	N/A -						
							Low binding	Yes	-	-	-						
							Standard	No	037650A	1000	N/A -						
							Standard	Yes	-	-	-						
	10	10 µl LongReach	45-34	0.38	2, 5, 10	Natural	Standard	No	037650TA	1000	N/A -						
							Standard	Yes	-	-	-						
							Low binding	No	-	-	-						
							Low binding	Yes	-	-	-						
							Standard	No	010440	1000	N/A -						
	200	200 µl Graduated STD	50.7	0.46	-	Natural	Standard	Yes	-	-	-						
							Low binding	No	-	-	-						
							Low binding	Yes	-	-	-						
							Standard	No	017020AA	1000	N/A -						
							Standard	Yes	-	-	-						
						Yellow	200	200 µl Graduated STDZN	51.44	0.46	1, 50, 100	Natural	Standard	No	015720A	1000	N/A -
													Standard	Yes	-	-	-
													Low binding	No	035080A	1000	N/A -
													Low binding	Yes	-	-	-
													Standard	No	032430A	1000	N/A -
Standard	Yes	-	-	-													
	300	300 µl NX	58.57	0.51	10, 50, 100	Natural	Standard	No	031770A	1000	N/A -						
							Standard	Yes	-	-	-						
							Low binding	No	031770TA	1000	N/A -						
							Low binding	Yes	-	-	-						
							Standard	No	130800A	1000	N/A -						
							Standard	Yes	-	-	-						
	300	300 µl XT	77.5	0.46	10, 50, 100, 200, 300	Natural	Low binding	No	130800TA	1000	N/A -						
							Low binding	Yes	-	-	-						
							Standard	No	010180	1000	N/A -						
							Standard	Yes	-	-	-						
							Low binding	No	035170A	1000	N/A -						
							Low binding	Yes	-	-	-						
	1000	1000 µl Standard	72.9	0.91	-	Natural	Standard	No	010040A	1000	N/A -						
							Standard	Yes	-	-	-						
							Low binding	No	031610A	768	N/A -						
							Low binding	Yes	-	-	-						
	1250	1000XT	102	0.81	200, 500, 1000	Natural	Standard	No	031610A	768	N/A -						
							Standard	Yes	-	-	-						

*Version without cells ** starter kit, including 1 tip refill, 1 charger and empty racks.

Empty CellRack with cover lid

Cat. No.	Description	Units/box	Price/box
028310	Empty rack for 10 to 200 µl tips	10	N/A -
028360	Empty rack for 10 µl G tips	10	N/A -

Empty CellRack with hinged lid

Cat. No.	Description	Units/box	Price/box
027280	Empty rack for 10 to 200 µl tips	10	N/A -
021750	Empty rack for 1250 µl tips	8	N/A -

Empty racks for Platinum tray

Cat. No.	Description	Units/box	Price/box
071000	Empty rack for 10 to 300 µl tips	1	N/A -
371000	Empty rack for 10 to 300 µl tips	24	N/A -
071010	Empty rack for 1250 µl tips	1	N/A -
371010	Empty rack for 1250 µl tips	16	N/A -

TIPS MICROPIPETTES

Multi Tips



Tips on CellRack with cover lid			Tips on CellRack with hinged lid			Tips on Quickrack			Tips on Tipstation			Starter kit			Tips on platinum refill		
Cat.No	Units/box	Price/box	Cat.No	Units/box	Price/box	Cat.No	Units/box	Price/box	Cat.No	Units/box	Price/box	Cat.No	Units/box	Price/box	Cat.No	Units/box	Price/box
-	-	-	030560A	10 x 96	N/A -	-	-	-	-	-	-	-	-	-	-	-	-
-	-	-	030570A	10 x 96	N/A -	-	-	-	-	-	-	-	-	-	-	-	-
027510	10 x 96	N/A -	-	-	-	-	-	-	-	-	-	-	-	-	-	-	-
027500	10 x 96	N/A -	-	-	-	-	-	-	-	-	-	-	-	-	-	-	-
135060	10 x 96	N/A -	-	-	-	-	-	-	-	-	-	-	-	-	-	-	-
135070	10 x 96	N/A -	-	-	-	-	-	-	-	-	-	-	-	-	-	-	-
023560A	10 x 96	N/A -	-	-	-	030470	5 x 960	N/A -	-	-	-	-	-	-	-	-	-
023570A	10 x 96	N/A -	-	-	-	-	-	-	-	-	-	-	-	-	-	-	-
035010A	10 x 96	N/A -	-	-	-	035030	5 x 960	N/A -	-	-	-	-	-	-	-	-	-
035020A	10 x 96	N/A -	-	-	-	-	-	-	-	-	-	-	-	-	-	-	-
037640A	10 x 96	N/A -	026400A	10 x 96	N/A -	037820	5 x 960	N/A -	027780	5 x 960	N/A -	170700	10 x 96**	N/A -	170500	4 x 960	N/A -
037660A	10 x 96	N/A -	026410A	10 x 96	N/A -	-	-	-	027790	5 x 960	N/A -	-	-	-	-	-	-
037640TA	10 x 96	N/A -	026400TA	10 x 96	N/A -	037820T	5 x 960	N/A -	027780T	5 x 960	N/A -	-	-	-	170600	4 x 960	N/A -
037660TA	10 x 96	N/A -	026410TA	10 x 96	N/A -	-	-	-	027790T	5 x 960	N/A -	-	-	-	-	-	-
010500A	10 x 96	N/A -	-	-	-	030450	5 x 960	N/A -	-	-	-	-	-	-	-	-	-
010520A	10 x 96	N/A -	-	-	-	-	-	-	027750	5 x 960	N/A -	-	-	-	-	-	-
-	-	-	-	-	-	030450T	5 x 960	N/A -	027740T	5 x 960	N/A -	-	-	-	-	-	-
-	-	-	-	-	-	-	-	-	027750T	5 x 960	N/A -	-	-	-	-	-	-
010620A	10 x 96	N/A -	-	-	-	030460	5 x 960	N/A -	027700	5 x 960	N/A -	-	-	-	-	-	-
010660A	10 x 96	N/A -	-	-	-	-	-	-	027710	5 x 960	N/A -	-	-	-	-	-	-
015660A	10 x 96	N/A -	026420A	10 x 96	N/A -	030430	5 x 960	N/A -	027760	5 x 960	N/A -	170710	10 x 96**	N/A -	170510	4 x 960	N/A -
015670A	10 x 96	N/A -	026430A	10 x 96	N/A -	-	-	-	027770	5 x 960	N/A -	-	-	-	-	-	-
-	-	-	026420TA	10 x 96	N/A -	035110	5 x 960	N/A -	027760T	5 x 960	N/A -	-	-	-	170610	4 x 960	N/A -
035100A	10 x 96	N/A -	026430TA	10 x 96	N/A -	-	-	-	027770T	5 x 960	N/A -	-	-	-	-	-	-
015360A	10 x 96	N/A -	-	-	-	030440	5 x 960	N/A -	027720	5 x 960	N/A -	170720	10 x 96**	N/A -	170520	4 x 960	N/A -
015370A	10 x 96	N/A -	-	-	-	-	-	-	027730	5 x 960	N/A -	-	-	-	-	-	-
031780A	10 x 96	N/A -	-	-	-	-	-	-	-	-	-	170730	10 x 96**	N/A -	170530	4 x 960	N/A -
031790A	10 x 96	N/A -	-	-	-	-	-	-	-	-	-	-	-	-	-	-	-
031780TA	10 x 96	N/A -	-	-	-	-	-	-	-	-	-	-	-	-	170620	4 x 960	N/A -
031790TA	10 x 96	N/A -	-	-	-	-	-	-	-	-	-	-	-	-	-	-	-
130920	10 x 96	N/A -	-	-	-	-	-	-	-	-	-	-	-	-	-	-	-
130930	10 x 96	N/A -	-	-	-	-	-	-	-	-	-	-	-	-	-	-	-
130920T	10 x 96	N/A -	-	-	-	-	-	-	-	-	-	-	-	-	-	-	-
130930T	10 x 96	N/A -	-	-	-	-	-	-	-	-	-	-	-	-	-	-	-
010200A*	10 x 100	N/A -	-	-	-	-	-	-	-	-	-	-	-	-	-	-	-
010230A*	10 x 100	N/A -	-	-	-	-	-	-	-	-	-	-	-	-	-	-	-
035180A*	10 x 100	N/A -	-	-	-	-	-	-	-	-	-	-	-	-	-	-	-
035190A*	10 x 100	N/A -	-	-	-	-	-	-	-	-	-	-	-	-	-	-	-
027110*	10 x 100	N/A -	-	-	-	-	-	-	-	-	-	-	-	-	-	-	-
027120*	10 x 100	N/A -	-	-	-	-	-	-	-	-	-	-	-	-	-	-	-
-	-	-	134750*	768	N/A -	134770	5 x 768	N/A -	-	-	-	170740	8 x 96**	N/A -	170540	4 x 768	N/A -
-	-	-	134760*	768	N/A -	-	-	-	-	-	-	-	-	-	-	-	-

*Version without cells ** starter kit, including 1 tip refill, 1 charger and empty racks.

TIPS
MICROPIPETTES

Multi filter tips

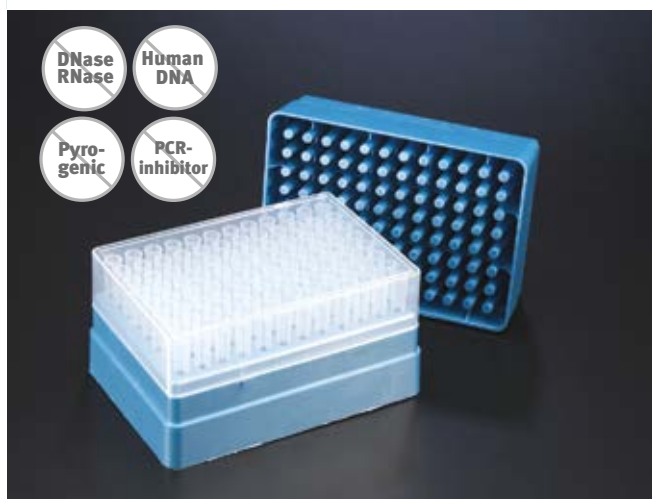

- ▶ Sterile tips
- ▶ Hydrophobic filter, preventing aerosols from rising up in the micropipette and the risk of contamination
- ▶ On a rack with a cover lid or a hinged lid (see descriptions of the racks on the previous page)
- ▶ In standard or low binding version



Attachment of the sample on the wall of a ordinary tip

The tip "low binding" allows you to eject the entire sample

Tips on CellRack with cover lid Tips on CellRack with hinged lid

Tips	Vol. (µl)	Model	Length (mm)	Ø opening (mm)	Graduation (µl)	Treatment	Cat.No	Units/box	Price/box	Cat.No	Units/box	Price/box
	10	10 µl Sharp	44.83	0.36	1, 2, 5, 10	Standard	-	-	-	130340	10 x 96	N/A -
						Low binding	-	-	-	-	-	-
	10	10 µl E (compatible Eppendorf)	45.5	0.38	10	Standard	015020	10 x 96	N/A -	-	-	-
						Low binding	035210	10 x 96	N/A -	-	-	-
	10	10 µl Ultra G (Gilson compatible)	28.8	0.38	2, 10	Standard	028200	10 x 96	N/A -	-	-	-
						Low binding	035200	10 x 96	N/A -	-	-	-
	10	10 µl LongReach	45.34	0.38	2, 5, 10	Standard	038000	10 x 96	N/A -	-	-	-
						Low binding	038000T	10 x 96	N/A -	030360T	10 x 96	N/A -
	20	20 µl Standard	50.7	0.46	-	Standard	014210	10 x 96	N/A -	-	-	-
						Low binding	035220	10 x 96	N/A -	030370T	10 x 96	N/A -
	100	100 µl Standard	50.7	0.46	-	Standard	036060	10 x 96	N/A -	-	-	-
						Low binding	036060T	10 x 96	N/A -	030380T	10 x 96	N/A -
	200	200 µl NX	58.57	0.51	10, 50, 100	Standard	030550	10 x 96	N/A -	-	-	-
						Low binding	030550T	10 x 96	N/A -	-	-	-
	200	200 µl Standard	50.7	0.46	-	Standard	014220	10 x 96	N/A -	-	-	-
						Low binding	014220T	10 x 96	N/A -	030390T	10 x 96	N/A -
	200	200 µl XT	77.5	0.46	10, 50, 100, 200	Standard	017370	10 x 96	N/A -	-	-	-
						Low binding	035240	10 x 96	N/A -	-	-	-
	300	300 µl XT	77.5	0.46	10, 50, 100, 200, 300	Standard	130510	10 x 96	N/A -	-	-	-
						Low binding	130510T	10 x 96	N/A -	-	-	-
	1000	1000 µl Standard	72.9	0.91	-	Standard	014200	10 x 100	N/A -	-	-	-
						Low binding	035260	10 x 100	N/A -	-	-	-
	1250	1000XT	102	0.81	200, 500, 1000	Standard	-	-	-	-	-	-
						Low binding	-	-	-	134000	10 x 96	N/A -

Tips not shown to scale.

ClearLine® Xtip4 Tips for Rainin LTS pipettes

- Graduated polypropylene tips
- Compatible with the LTS Micropipettes
- Flexibility of the tip for lower insertion force and good sealing
- Locking device on the tip to reduce the ejection force
- No droplet formation at the tip
- Low binding



Xtip4 tips without filter

Vol. (µl)	Units/box	On a rack				RechargeTipEject	
		Non-sterile		Sterile		Sterile	
		Cat. No.	Price/box	Cat. No.	Price/box	Cat. No.	Price/box
20	10 x 96	-	-	713181B	N/A -	713193B	N/A -
250	10 x 96	713185B	N/A -	-	-	713194B	N/A -
1000	8 x 96	713298	N/A -	713296	N/A -	713195B	N/A -
1200	8 x 96	713299	N/A -	-	-	-	-

Xtip4 sterile filter tips

Volume (µl)	Units/box	Cat. No.	Price/box
1000	8 x 96	713294	N/A -
1200	8 x 96	713295	N/A -

Accessories

Cat. No.	Description	Units/box	Price/box
713196B	Empty box for refill Xtip4 20 - 300 µl	50	N/A -
713197B	Empty box for refill Xtip4 1000 - 1200 µl	40	N/A -

Instructions for use: Tip Eject refill

- Tower containing 10 trays of 96 sterile tips
- Easy one-handed operation
- Recyclable packaging
- 1°/remove the protective rack at the base of the column
- 2°/place the tower on the empty rack
- 3°/press the top - a "click" indicates that the tray is correctly positioned in the rack
- 4°/replace the column on the protective rack

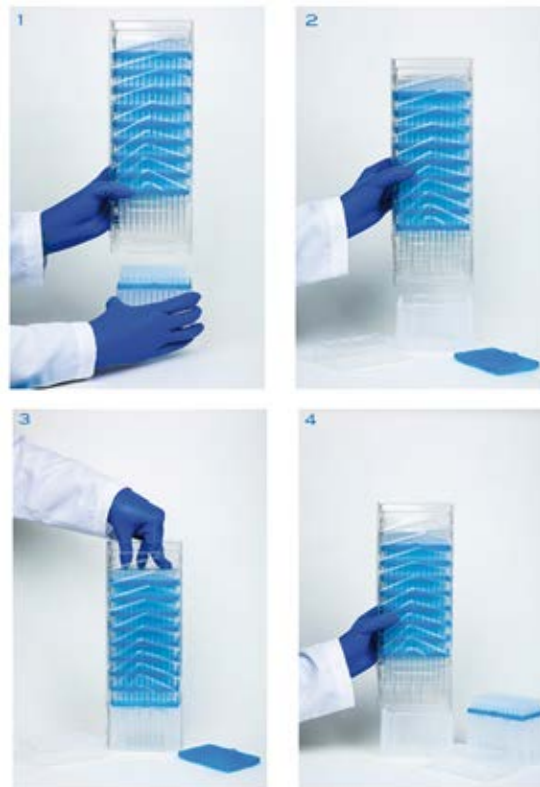

2 in 1 system!
 Work with the ClearLine® non filter and filter range and reduce your waste: consider reusing your hinged racks with the refill systems



TIPS
MICROPIPETTES

Neptune tips



➤ High precision tips compatible with all brands of standard micropipettes



Empty racks with tip holder

Cat. No.	Description	Price
713234A	Empty rack with tray for 10 µl tips, bulk	N/A -
713236A	Empty rack with tray for 20 to 300 µl tips, bulk	N/A -
713238A	Empty rack with tray for 1000 to 1250 µl tips, bulk	N/A -
713235A	Empty rack without tray for 10 to 300 µl refill tips	N/A -
713237A	Empty rack without tray for 1000 to 1250 µl refill tips	N/A -

Photo	Type	Vol. (µl)	Long. (mm)	Ø (mm) opening	Graduat. (µl)	Type	Sterile	In bulk			On a rack			In refill		
								Cat.No	Units/box	Price/box	Cat.No	Units/box	Price/box	Cat.No	Units/box	Price/box
	2040	10	31.24	0.46	0.5, 2, 10	Standard	No	713123	1000	N/A -	713124N	960	N/A -	713126N	1920	N/A -
						Standard	Yes	-	-	-	713125N	960	N/A -	-	-	-
						Low Bind.	No	-	-	-	713007N	960	N/A -	712159N	1920	N/A -
						Low Bind.	Yes	-	-	-	713008N	960	N/A -	-	-	-
	2340	10	45.84	0.38	2, 10	Standard	No	-	-	-	711176N	960	N/A -	713092N	960	N/A -
						Standard	Yes	-	-	-	713011N	960	N/A -	-	-	-
						Low Bind.	No	713164A	1000	N/A -	713282	960	N/A -	713288	960	N/A -
						Low Bind.	Yes	-	-	-	713163NA	960	N/A -	-	-	-
	2140	10	45.72	0.46	-	Low Bind.	No	-	-	-	713013N	960	N/A -	-	-	-
						Standard	Yes	-	-	-	-	-	-	-	-	-
	2100	200	50.75	0.53	10, 50, 100	Standard	No	-	-	-	713021N	960	N/A -	713040B	960	N/A -
						Standard	Yes	-	-	-	713022N	960	N/A -	-	-	-
						Low Bind.	No	713015	1000	N/A -	713283	960	N/A -	711511N	960	N/A -
						Low Bind.	Yes	-	-	-	713017N	960	N/A -	-	-	-
	2150	200	90.93	0.46	-	Standard	No	-	-	-	713284	768	N/A -	-	-	-
						Standard	Yes	-	-	-	713285	768	N/A -	-	-	-
	2090	300	59.54	0.51	10, 50, 100	Standard	No	713281	100	N/A -	713286	768	N/A -	713093N	960	N/A -
						Standard	Yes	-	-	-	713287	768	N/A -	-	-	-
						Low Bind.	No	713042	1000	N/A -	713046N	960	N/A -	713090N	960	N/A -
						Low Bind.	Yes	-	-	-	713047N	960	N/A -	-	-	-
	2160	1000	81.79	0.89	200, 500, 1000	Standard	No	713023	1000	N/A -	-	-	-	712160N	960	N/A -
						Standard	Yes	-	-	-	713024N	768	N/A -	-	-	-
	2370	1250	98.4	0.89	10, 50, 100	Standard	No	713095	1000	N/A -	-	-	-	713094N	960	N/A -
						Low Bind.	No	713289	968	N/A -	-	-	-	713091N	960	N/A -

Neptune filter tips

NEPTUNE
Next-Gen Life Sciences

- Filter tips
- On a hinged rack
- Sterile



Photo	Type	Vol. (µl)	Long. (mm)	Ø (mm) opening	Graduation (µl)	Type	Cat.No	Units/box	Price/box
	BT10	10	31.24	0.46	0.5, 2, 10	Low binding	713001N	10 x 96	N/A -
						Standard	713122N	10 x 96	N/A -
	BT10XL	10	45.84	0.38	2, 10	Low binding	713078N	10 x 96	N/A -
						Standard	711177N	10 x 96	N/A -
	BT10E	10	45.72	0.46	-	Low binding	713002N	10 x 96	N/A -
	BT10F	10	50.75	0.53	10	Low binding	713003N	10 x 96	N/A -
	BT20	20	50.75	0.53	10	Low binding	711178N	10 x 96	N/A -
	BT100	100	59.54	0.51	10, 50, 100	Low binding	711179N	10 x 96	N/A -
	BTXLT	180	90.93	0.46	-	Standard	713279	8 x 96	N/A -
	BT200	200	59.54	0.51	10, 50, 100	Low binding	711181N	10 x 96	N/A -
						Standard	713280	8 x 96	N/A -
	BT200XLT	200	90.93	0.46	-	Standard	713280	8 x 96	N/A -
	BT300	300	59.54	0.51	10, 50, 100	Low binding	713079N	10 x 96	N/A -
	BT1000	1000	81.78	0.59	200, 500, 1000	Low binding	713103N	8 x 96	N/A -
						Standard	713104N	8 x 96	N/A -
	BT1250	1250	98.4	0.89	200, 500, 1000	Low binding	713077NA	8 x 96	N/A -
						Standard	713080N	8 x 96	N/A -

ART filter tips for Rainin

- Available in 20, 200, 300, 1000 and 1200 µl
- For Rainin LTS pipettes

- Hinged transparent racks with coloured inserts associated with volume or refills

Type	Vol. (µl)	Pack. unit	Standard Tips		Low Retention Tips	
			Sterile hinged lid rack	On sterile refill	Sterile hinged lid rack	On sterile refill
ART 20L	20	10 x 96	038561	041546	038560	041545
ART 200L	200	10 x 96	038563	041548	038562	041547
ART 300L	300	10 x 96	038559	041544	038558	041543
ART 1000L	1000	8 x 96	038565	041560	038564	-
ART 1200L	1200	8 x 96	038567	041562	038566	041561
Price			N/A -	N/A -	N/A -	N/A -



TIPS
MICROPIPETTES

ART filter tips



All brands of micropipettes have a perfectly fitting ART tip.

The Softfit tip has a reinforced seal.

The hydrophobic filter prevents any accidental backflow of liquid into the filter and pipette.

All ART tips are sterile, (except those in bulk packaging).

The ART tip is available in a standard version, or a low retention version for improved sample recovery.

A wide range of presentations:

- on a single rack with a cover lid;
- on individual hinged-lid racks;
- In bulk;
- in individual refills: the sterile tips are placed on a tray under an individual blister pack;
- in tray refills, ready to use

- 1) Hold the top of the blister pack and remove the peel-off sheet.
- 2) Place the blister pack on the rack.
- 3) Press.

Sterile refills



Model	Vol. (µl)	Length (mm)	Features	Compatibility	Pack unit
ART 10 Reach	0 – 10	43.3	Ideal for micro-volumes, long length suitable for microtubes	Gilson P2-P10, Finnpiquette 2 and 10 µl micro, Sartorius Biohitfamily 10 µl, Eppendorf 2.5 µl	10 x 96
ART 10	0 – 10	31.3	Low volume	Gilson P2-P10, Finnpiquette 2 and 10 µl, Sartorius Biohitfamily 10 µl	10 x 96
ART 20E	0 – 20	47.7	Low volume	Eppendorf 10 µl, Socorex 10 µl	10 x 96
ART 10F	0 – 10	58.8	Low volume	Finnpiquette 10 µl universal, Sartorius Biohitfamily 10 µl	10 x 96
ART 20P	0 – 20	50.7	Universal	Gilson P20, Eppendorf 20 µl, Socorex 20 µl	10 x 96
ART 20	0 – 20	45.7	-	Eppendorf 10 µl	10 x 96
ART 50U	0 – 50	52	Softfit, with reinforced rack, special multi-channel	Multichannel (Labsystems 5 - 50 µl, Sartorius Biohitfamily 5 - 50 µl, Eppendorf 5 - 50 µl)	10 x 96
ART 100	1 – 100	58.8	-	Finnpiquette 40 µl Multichannel (Labsystems 5 - 50 µl, Sartorius Biohitfamily 5 - 50 µl)	10 x 96
ART 100E	1 – 100	50.7	Universal	Gilson P100, Eppendorf 100 µl, Sartorius Biohitfamily 50 µl and electronic 100 µl	10 x 96
ART 200	1 – 200	58.8	Universal	Gilson P200, Eppendorf 200 µl, Finnpiquette 200 µl, Sartorius Biohitfamily 200 µl	10 x 96
ART 200 REACH	1 – 200	90.9	Long length	Gilson P200, Eppendorf 200 µl, Finnpiquette 200 µl, Sartorius Biohitfamily 200 µl	8 x 96
ART 200U	1 – 200	52	Softfit, with reinforced rack, special multi-channel	Multichannel (Labsystems 50 - 300 µl, Eppendorf 50 - 300 µl), any 200 µl pipette	10 x 96
ART 200G	5 – 200	49.7	Large orifice for fragile cells, DNA and viscous solutions	Gilson P200, Eppendorf 200 µl, Finnpiquette 200 µl, Sartorius Biohitfamily 200 µl	10 x 96
ART 300	1 – 300	58.4	Multi-channel special	Multichannel (Sartorius Biohitfamily 250 µl, Finnpiquette 300 µl), Eppendorf Research Pro 300 µl	10 x 96
ART 500	50 – 500	79	Softfit	Eppendorf 50 - 250 µl, Sartorius Biohitfamily 50 - 500 µl	8 x 100
ART 1000	100 – 1000	79	Softfit	Gilson P1000, Eppendorf 1000 µl, Finnpiquette 1000 µl, Sartorius Biohitfamily 1000 µl	8 x 100
ART 1000E	100 – 1000	102.2	Long length	Gilson P1000, Finnpiquette 1000 µl, Sartorius Biohitfamily 1000 µl, Eppendorf 1000 µl	8 x 100
ART 1000G	100 – 1000	85.4	Large orifice for fragile cells, DNA and viscous solutions	Gilson P1000, Eppendorf 1000 µl, Finnpiquette 1000 µl, Sartorius Biohitfamily 1000 µl	8 x 100
ART 1000 REACH	100 – 1000	118	Long length, Softfit	Gilson P1000, Eppendorf 1000 µl, Finnpiquette 1000 µl, Sartorius Biohitfamily 1000 µl	8 x 96
ART 1250 REACH	100 – 1250	102.2	Long length	-	8 x 96
ART 5000	1000 - 5000	117	-	Gilson P5000	Sterile bag of 250 tips
ART GEL 20P	0.5 – 20	70.9	A flexible capillary for gel coating	Gilson P20, Eppendorf 20 µl, Finnpiquette 10 µl	10 x 96
ART GEL	0.5 – 100	70.9	A flexible capillary for gel coating	Gilson P100, Eppendorf 100 µl, Finnpiquette 40 µl	10 x 96
ART XLP	5 – 100	91.2	Long length; reaches the bottom of 12 x 75 mm tubes	Gilson P100, Eppendorf 100 µl, Finnpiquette 40 µl	8 x 96
ART XLP 200	5 – 200	91.2	Long length; reaches the bottom of 12 x 75 mm tubes	Gilson P200, Eppendorf 200 µl, Socorex 1000 µl	8 x 96
ART XLG	5 – 200	91.2	Long length and wide opening for cells, DNA and viscous solutions	Gilson P200, Eppendorf 100 µl, Eppendorf 200 µl, Finnpiquette 40 µl	8 x 96
ART 1000 XL	100 - 1000	89	Universal	Gilson P1000, Eppendorf 1000 µl, Sartorius Biohitfamily 1000 µl Finnpiquette 1000 µl	8 x 96

"Essential" Kits

➤ "Essential" hinged rack kits contains:

- ART 200 (Cat. No. 038019) x 4
- ART 10 reach (Cat. No. 038001) x 4
- ART 1000XL (Cat. No. 041539) x 4

➤ "Essential" refill insert kits contains:

- ART 200 (Cat. No. 038019) x 4
- ART 10 reach (Cat. No. 038001) x 4
- ART 1000XL (Cat. No. 041539) x 4

Cat.No	Description	Price
041604	"essential" ART tips Kit: 4 hinged racks of each tip Cat. No. 038019, Cat. No. 038001, Cat. No. 041539	N/A -
041605	"essential" ART tips Kit: 4 refill inserts of each tip Cat. No. 038019, Cat. No. 038001, Cat. No. 041539	N/A -

Tips not shown to scale.

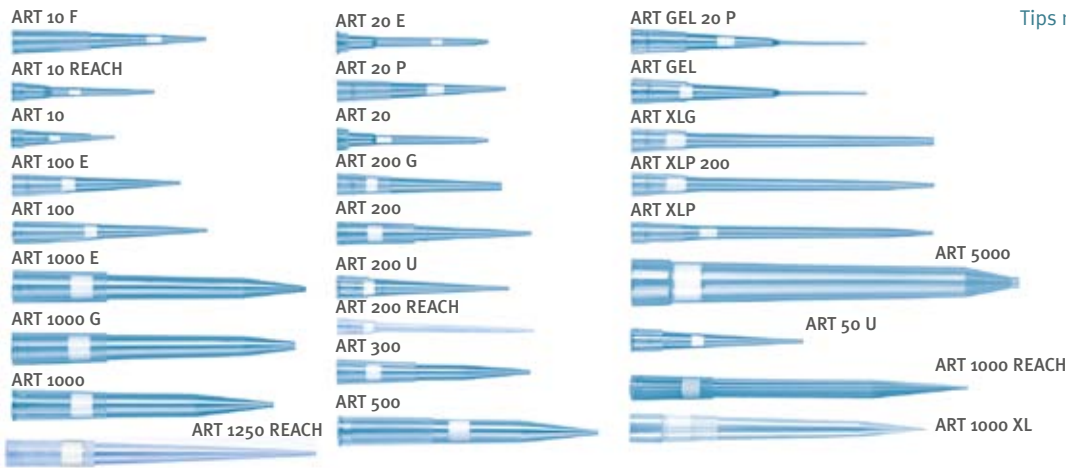

Standard Tips								Low Retention Tips							
On a sterile rack with cover lid		On a sterile rack with hinged lid		In individual sterile refills		Refill on sterile tray		On a sterile rack with cover lid		On a sterile rack with hinged lid		In individual sterile refills		Refill on sterile tray	
Cat.No	Price	Cat.No	Price	Cat.No	Price	Cat.No	Price	Cat.No	Price	Cat.No	Price	Cat.No	Price	Cat.No	Price
038001	N/A -	041529	N/A -	041530	N/A -	-	-	038356	N/A -	041527	N/A -	041528	N/A -	-	-
038003	N/A -	041525	N/A -	041526	N/A -	041631	N/A -	038357	N/A -	041523	N/A -	041524	N/A -	041630	N/A -
038005	N/A -	041533	N/A -	041538	N/A -	-	-	-	-	041531	N/A -	041532	N/A -	-	-
038007	N/A -	-	-	-	-	-	-	038359	N/A -	-	-	-	-	-	-
038009	N/A -	041536	N/A -	041537	N/A -	-	-	038360	N/A -	041534	N/A -	041535	N/A -	-	-
038011	N/A -	-	-	-	-	041633	N/A -	-	-	-	-	-	-	-	-
038013	N/A -	-	-	-	-	-	-	-	-	-	-	-	-	-	-
038015	N/A -	041517	N/A -	041518	N/A -	-	-	-	-	-	-	-	-	-	-
038017	N/A -	041515	N/A -	041516	N/A -	-	-	038361	N/A -	041513	N/A -	041514	N/A -	-	-
038019	N/A -	041521	N/A -	041522	N/A -	041621	N/A -	038362	N/A -	041519	N/A -	041520	N/A -	-	-
-	-	041635	N/A -	-	-	-	-	-	-	041634	N/A -	-	-	-	-
038021	N/A -	-	-	-	-	-	-	-	-	-	-	-	-	-	-
038023	N/A -	-	-	-	-	-	-	-	-	-	-	-	-	-	-
038025	N/A -	041624	N/A -	-	-	041625	N/A -	-	-	041622	N/A -	-	-	041623	N/A -
-	-	-	-	-	-	-	-	-	-	-	-	-	-	-	-
038029	N/A -	-	-	-	-	041637**	N/A -	038366	N/A -	-	-	-	-	-	-
038031	N/A -	-	-	-	-	-	-	-	-	-	-	-	-	-	-
038033	N/A -	-	-	-	-	-	-	-	-	-	-	-	-	-	-
038354***	N/A -	041627	N/A -	-	-	-	-	-	-	041626	N/A -	-	-	-	-
-	-	041629	N/A -	-	-	-	-	-	-	041628	N/A -	-	-	-	-
-	-	-	-	-	-	-	-	-	-	-	-	-	-	-	-
038036	N/A -	-	-	-	-	-	-	-	-	-	-	-	-	-	-
038038	N/A -	-	-	-	-	-	-	-	-	-	-	-	-	-	-
038040	N/A -	-	-	-	-	-	-	-	-	-	-	-	-	-	-
038042	N/A -	-	-	-	-	-	-	-	-	-	-	-	-	-	-
038044	N/A -	-	-	-	-	-	-	-	-	-	-	-	-	-	-
-	-	041541	N/A -	041542	N/A -	-	-	-	-	041539	N/A -	041540	N/A -	041636*	N/A -

Empty racks

Cat. No.	Description	Units/box	Price/box
041510	Small volume empty rack (10 µl, 20 µl)	10	N/A -
041511	Medium volume empty rack (20 µl, 200 µl, 300 µl)	10	N/A -
041512	Large volume empty rack (1000 µl)	8	N/A -

(*): Packaging unit: 1000

(**): Packaging unit: 56 x 10

(***): Packaging unit: 8 x 100

(****) in a sterile bag

ART Tips

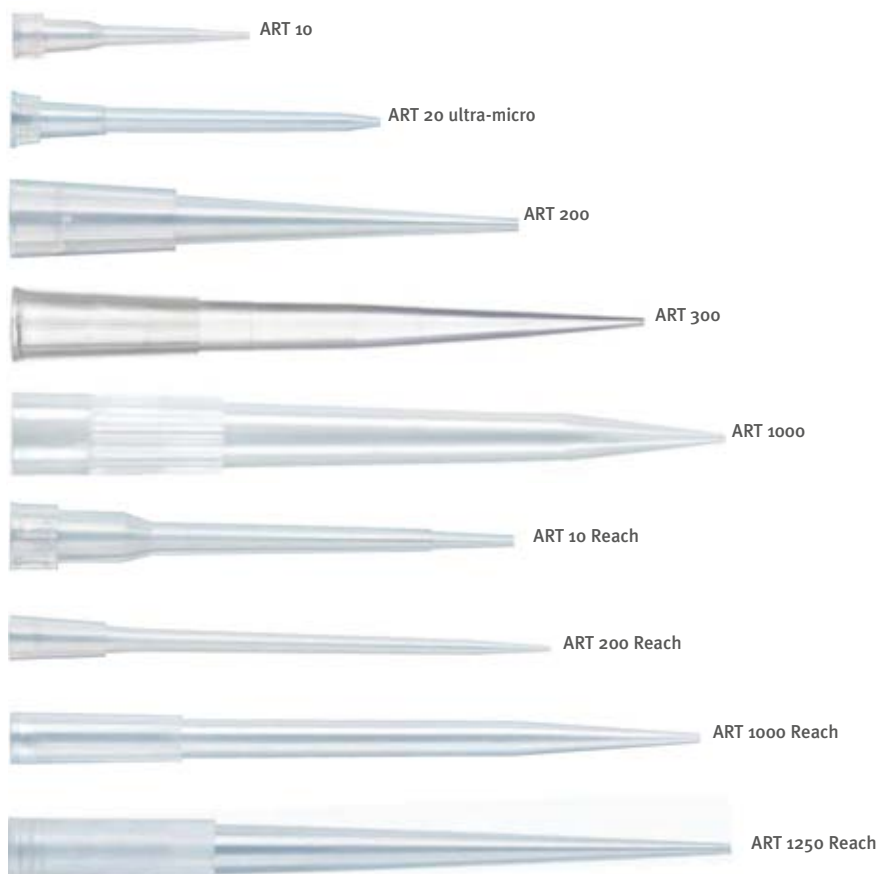

► With reversible hinged lid to obtain a box with a covering lid

Tips not shown to scale.

Model	Vol. (µl)	Long. (mm)	On rack, non-sterile			On rack, sterile			Reload, non stérile			Reload, sterile			Non-sterile bulk		
			Cat.No	Units/ box	Price/ box	Cat.No	Units/ box	Price/ box	Cat.No	Units/ box	Price/ box	Cat.No	Units/ box	Price/ box	Cat.No	Units/ box	Price/ box
ART 10	10	31.3	041656	960	N/A -	041652	960	N/A -	041657	960	N/A -	041653	960	N/A -	-	-	-
ART 20 ultra-micro	10 - 20	45.7	041668	960	N/A -	041664	960	N/A -	041669	960	N/A -	041665	960	N/A -	038192	1000	N/A -
ART 200	200	50.7	041680	960	N/A -	041676	960	N/A -	041681	960	N/A -	041677	960	N/A -	038460	1000	N/A -
ART 300	300	58.4	041690	960	N/A -	041684	960	N/A -	041691	960	N/A -	041685	960	N/A -	-	-	-
ART 1000	1000	88.9	041644	960	N/A -	041640	768	N/A -	041645	560	N/A -	041641	560	N/A -	-	-	-

Standard long tips

ART 10 Reach	10	43.4	041661	960	N/A -	041659	960	N/A -	-	-	-	-	-	-	038355	1000	N/A -
ART 200 Reach	200	90.9	041673	768	N/A -	041671	768	N/A -	-	-	-	-	-	-	038159	1000	N/A -
ART 1000 Reach	1000	118.5	041695	768	N/A -	041693	768	N/A -	-	-	-	-	-	-	-	-	-
ART 1250 Reach	1250	102.2	041649	768	N/A -	041647	768	N/A -	-	-	-	-	-	-	-	-	-

Low Retention Tips

ART 10 LR	10	31.3	041654	960	N/A -	041650	960	N/A -	041655	960	N/A -	041651	960	N/A -	-	-	-
ART 20 ultra-micro LR	10 - 20	45.7	041666	960	N/A -	041662	960	N/A -	041667	960	N/A -	041663	960	N/A -	-	-	-
ART 200 LR	200	50.7	041678	960	N/A -	041674	960	N/A -	041679	960	N/A -	041675	960	N/A -	-	-	-
ART 300 LR	300	58.4	041687	960	N/A -	041682	960	N/A -	041688	960	N/A -	041683	960	N/A -	-	-	-
ART 1000 LR	1000	88.9	041642	768	N/A -	041638	768	N/A -	041643	560	N/A -	041639	560	N/A -	-	-	-

Low Retention long tips

ART 10 Reach LR	10	43.4	041660	960	N/A -	041658	960	N/A -	-	-	-	-	-	-	-	-	-
ART 200 Reach LR	200	90.9	041672	768	N/A -	041670	768	N/A -	-	-	-	-	-	-	-	-	-
ART 1000 Reach LR	1000	118.5	041694	768	N/A -	041692	768	N/A -	-	-	-	-	-	-	-	-	-
ART 1250 Reach LR	1250	102.2	041648	768	N/A -	041646	768	N/A -	-	-	-	-	-	-	-	-	-

Empty racks

Cat. No.	Description	Units/ box	Price/ box
041510	Small volume empty rack (10 µl, 20 µl)	10	N/A -
041511	Medium volume empty rack (20 µl, 200 µl, 300 µl)	10	N/A -
041512	Large volume empty rack (1000 µl)	8	N/A -

Treff® universal tips without collar

- Tips with or without filter
- Wide choice of presentation: in bulk, in rack or in refill
- Universal, can be used with all micropipettes



- Autoclavable non filter tips
- Fully automated production in a clean room class 8 according to ISO 14644-1



Non-sterile Tips

Tips not shown to scale.	Vol. (µl)	Description	In bulk			In a rack			In refill			In ECO refill		
			Cat.No	Units/box	Price/box	Cat.No	Units/box	Price/box	Cat.No	Units/box	Price/box	Cat.No	Units/box	Price/box
	0.1 - 20	«Nano», Universal	034099B	1000	N/A -	034076B	5 x 96	N/A -	982747	10 x 96	N/A -	-	-	-
	0.5 - 20	«Crystal», Universal	034059B	1000	N/A -	982703	5 x 96	N/A -	034083B	10 x 96	N/A -	982742	10 x 96	N/A -
	1 - 50	Ultra-micro, Universal	982700	1000	N/A -	982704	5 x 96	N/A -	982721	10 x 96	N/A -	-	-	-
	2 - 200	Universal	034070B	1000	N/A -	034196	5 x 96	N/A -	034080B	10 x 96	N/A -	034197	10 x 96	N/A -
	5 - 300	Universal	034088B	1000	N/A -	034078B	5 x 96	N/A -	034081B	10 x 96	N/A -	-	-	-
	50 - 1000	Universal	034071	1000	N/A -	034079B	5 x 96	N/A -	034082B	10 x 96	N/A -	982743	10 x 96	N/A -
	500 - 5000	Universal	034065B	200	N/A -	-	-	-	-	-	-	-	-	-
	1000 - 10000	Universal	982702	200	N/A -	-	-	-	-	-	-	-	-	-

Sterile tips

Vol. (µl)	Description	In a rack			In refill			In ECO refill		
		Cat.No	Units/box	Price/box	Cat.No	Units/box	Price/box	Cat.No	Units/box	Price/box
0.1 - 20	«Nano», Universal	982705	10 x 96	N/A -	982722	10 x 96	N/A -	-	-	-
0.5 - 20	«Crystal», Universal	982706	10 x 96	N/A -	982723	10 x 96	N/A -	982744	10 x 96	N/A -
1 - 50	Ultra-micro, Universal	982707	10 x 96	N/A -	982724	10 x 96	N/A -	-	-	-
2 - 200	Universal	982708	10 x 96	N/A -	982725	10 x 96	N/A -	982745	10 x 96	N/A -
5 - 300	Universal	982709	10 x 96	N/A -	982726	10 x 96	N/A -	-	-	-
50 - 1000	Universal	982710	10 x 96	N/A -	982727	10 x 96	N/A -	982746	10 x 96	N/A -

Boxes with support grid for tips without collar

Cat.No	For tips	Price
982850	20 µl and 50 µl	N/A -
982851	200 µl	N/A -
982852	300 µl	N/A -
982853	1000 µl	N/A -

Filter tips

Vol. (µl)	Description	In a rack			In refill			Sterile in rack			Sterile in refill		
		Cat.No	Units/box	Price/box	Cat.No	Units/box	Price/box	Cat.No	Units/box	Price/box	Cat.No	Units/box	Price/box
0.1 - 1	«Nano», Universal	982711	5 x 96	N/A -	982728	10 x 96	N/A -	982718	10 x 96	N/A -	982735	10 x 96	N/A -
0.5 - 10	«Crystal», Universal	982712	5 x 96	N/A -	982729	10 x 96	N/A -	982719	10 x 96	N/A -	982736	10 x 96	N/A -
1 - 20	Ultra-micro, Universal	982713	5 x 96	N/A -	982730	10 x 96	N/A -	034093B	10 x 96	N/A -	982737	10 x 96	N/A -
2 - 20	Ultra-micro, Universal	982714	5 x 96	N/A -	982731	10 x 96	N/A -	982720	10 x 96	N/A -	982738	10 x 96	N/A -
5 - 100	Universal	982715	5 x 96	N/A -	982732	10 x 96	N/A -	034095B	10 x 96	N/A -	982739	10 x 96	N/A -
5 - 200	Universal	982716	5 x 96	N/A -	982733	10 x 96	N/A -	034148B	10 x 96	N/A -	982740	10 x 96	N/A -
50 - 1000	Universal	982717	5 x 96	N/A -	982734	10 x 96	N/A -	034098B	10 x 96	N/A -	982741	10 x 96	N/A -

Non-sterile tips with collar

Vol. (µl)	Description	In Bulk with collar			Associated racks	
		Cat.No	Units/box	Price/box	Cat.No	Price/box
2 - 200	Universal	034066B	1000	N/A -	034068	N/A -
50 - 1000	Universal	034067B	1000	N/A -	034069	N/A -

- Autoclavable tips
- Associated racks in autoclavable polycarbonate

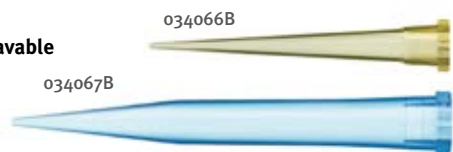

Treff® Empty racks

Cat.No	Description	Units/box	Price/box
982897	Empty Rack volume 200 µl	12	N/A -
034127	Empty Rack volume 300 µl	12	N/A -
982898	Empty rack volume 1000µl	12	N/A -
982899	Empty box	12	N/A -

- In polycarbonate
- Autoclavable at 121 °C
- Racks for 128 tips
- 3 colours: yellow (200 µl), green (300 µl), blue (1000 µl)
- Fully automated production in a clean room class 8 according to ISO 14644-1



Greiner Bio-One Tips

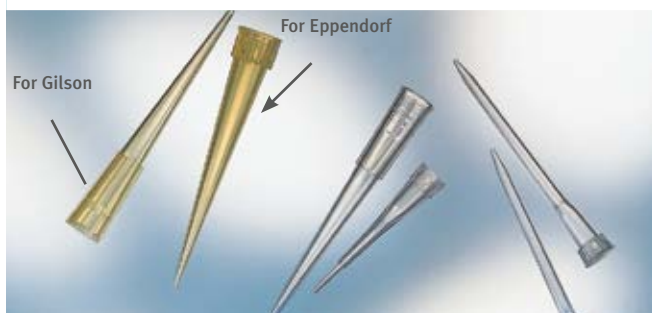

- Complete range of tips adapted to the majority of pipettors on the market, both for micro-volumes (with tips for PIPETMAN® Gilson P2 and P10 and Eppendorf 0.5 - 10 µl), and for macro-volumes (with tips of 5000 µl)
- Tips available in two versions, graduated and non graduated (the graduation allows to control the accuracy of the pipetting)

Tips on autoclavable rack

Cat.No	Volume (µl)	Colour	Sterile	Graduated	Adapted for	Units/rack	Price/Rack
771280	0.5 - 10	Natural	No	Yes	Gilson	96	N/A -
771281	0.5 - 10	Natural	Yes*	Yes	Gilson	96	N/A -
685261	10 - 200	Yellow	Yes*	No	Eppendorf	96	N/A -
739265	10 - 200	Yellow	No	Yes	Universal	96	N/A -
739266	10 - 200	Yellow	Yes*	Yes	Universal	96	N/A -

* the purchase of a complete box is necessary to obtain the certificate

Tips, bulk

Cat.No	Volume (µl)	Colour	Graduated	Adapted for	Units/bag	Price/bag
765290	0.5 - 20	Natural	No	Eppendorf	1000	N/A -
686295	100 - 1000	Natural	No	Eppendorf	250	N/A -
740296	100 - 1000	Blue	Yes	Universal	250	N/A -
070002	100 - 5000	Natural	No	Gilson	250	N/A -

Greiner Bio-One Easy Load refill systems



- Greiner Bio-One Easy Load systems for fast refilling of empty tip racks
- Available with 0.5 µl, 1 - 200 µl and 100 - 1000 µl tips
- Saves time while minimising waste
- Autoclavable Easy Load racks with hinged lid for easy handling
- Available in sterile and non-sterile versions
- Easy Load 200 and 1000 systems are available with universal graduated tips
- Grid moulded into the rack
- Stackable racks
- Easy positioning of the refill
- 3 rack colours: green (10 µl), yellow (200 µl) and blue (1000 µl)

Cat. No.	Description	Rack colours	Volume (µl)	Colour tips	Sterile	Pack unit.	Units/box	Price/box
741015	Easy Load 10	Green	0.5 - 10	Natural	No	10 x 96	6 x 960	N/A -
741065	Easy Load 200	Yellow	1 - 200	Yellow	No	10 x 96	6 x 960	N/A -
741035	Easy Load 1000	Blue	100 - 1000	Natural	No	6 x 60	6 x 360	N/A -
741040	Easy Load 1000	Blue	100 - 1000	Natural	Yes	6 x 60	6 x 360	N/A -
741045	Easy Load 1000	Blue	100 - 1000	Blue	No	6 x 60	6 x 360	N/A -
741050	Easy Load 1000	Blue	100 - 1000	Blue	Yes	6 x 60	6 x 360	N/A -
941300	Rack for Easy Load 10	Green	-	-	-	10	10	N/A -
941320	Rack for Easy Load 1000	Blue	-	-	-	10	10	N/A -

* Consists of 2 refills of 960 tips and 10 racks for Easy Load 200.

Labcon Standard Tips



► In resealable bags, in rack or in individual packaging



Description	Length (mm)	In a rack			In sterile rack			In a bag			Individual packaging		
		Cat.No	Pack unit.	Price	Cat.No	Pack unit.	Price	Cat.No	Pack unit.	Price	Cat.No	Pack unit.	Price
10 µl with ultrafine tip	31.4	949391	96 x 12	N/A -	949402	96 x 12	N/A -	949505	1000	N/A -	-	-	-
10 µl with ultrafine silicon tip	31.4	949684	96 x 120	N/A -	949685	96 x 120	N/A -	949683	1000 x 10	N/A -	-	-	-
10 µl long tip with TubeGuard	38.1	949392	96 x 10	N/A -	949403	96 x 10	N/A -	949382	1000	N/A -	-	-	-
10 µl with ultrafine tip	47.6	949626	96 x 100	N/A -	949627	96 x 100	N/A -	949625	1000 x 10	N/A -	-	-	-
50 µl for 16 channel Finnpiquette	32.9	949540	384 x 50	N/A -	949541	384 x 50	N/A -	-	-	-	-	-	-
100 µl with bevelled tip for Eppendorf Yellow	49.7	949617	96 x 100	N/A -	949618	96 x 100	N/A -	949616	1000 x 10	N/A -	-	-	-
200 µl with yellow bevelled tip	49.7	949396	96 x 10	N/A -	949407	96 x 10	N/A -	949378	1000	N/A -	949472	200	N/A -
200 µl with transparent bevelled tip	49.7	949394	96 x 10	N/A -	949405	96 x 10	N/A -	949384	1000	N/A -	-	-	-
200 µl with bevelled tip Transparent, graduated	49.7	949395	96 x 10	N/A -	949406	96 x 10	N/A -	949385	1000	N/A -	949473	200	N/A -
200 µl yellow standard tip	49.7	949611	96 x 100	N/A -	949612	96 x 100	N/A -	949610	1000 x 10	N/A -	-	-	-
200 µl standard clear tip	49.7	949708	96 x 100	N/A -	949709	96 x 100	N/A -	949707	1000 x 10	N/A -	-	-	-
200 µl siliconised bevelled tip	49.7	949687	96 x 100	N/A -	949688	96 x 100	N/A -	949686	1000 x 10	N/A -	-	-	-
200 µl capillary tip 30 mm	82.5	949620	96 x 48	N/A -	949621	96 x 48	N/A -	949619	1000 x 10	N/A -	-	-	-
200 µl wide opening	49.7	949591	96 x 100	N/A -	949592	96 x 100	N/A -	949590	1000 x 10	N/A -	-	-	-
250 µl with ultrafine tip	52.1	949397	96 x 10	N/A -	949408	96 x 10	N/A -	949386	1000	N/A -	-	-	-
300 µl with bevelled tip	52.1	949636	96 x 100	N/A -	949637	96 x 100	N/A -	949635	1000 x 10	N/A -	949632	200 x 10	N/A -
1000 µl with blue ultrafine tip	75.9	949399	96 x 6	N/A -	949410	96 x 6	N/A -	949388	1000	N/A -	-	-	-
1000 µl with transparent ultrafine tip	75.9	949398	96 x 6	N/A -	949409	96 x 6	N/A -	949387	1000	N/A -	-	-	-
1200 µl with ultrafine tip for Sartorius pipette	88.9	949652	96 x 48	N/A -	949653	96 x 48	N/A -	949651	1000 x 10	N/A -	949474	200	N/A -
1250 µl wide opening	88.9	949401	96 x 6	N/A -	949412	96 x 6	N/A -	949390	1000	N/A -	-	-	-
Tips for Rainin LTS													
20 µl for Rainin LTS	48.3	949547	96 x 100	N/A -	949548	96 x 100	N/A -	949546	1000 x 10	N/A -	-	-	-
250 µl for Rainin LTS	51.3	949578	96 x 100	N/A -	949579	96 x 100	N/A -	949577	1000 x 10	N/A -	-	-	-
300 µl for Rainin LTS	55.6	949561	96 x 100	N/A -	949562	96 x 100	N/A -	949560	1000 x 10	N/A -	-	-	-
1200 µl for Rainin LTS	88.9	949584	96 x 48	N/A -	949585	96 x 48	N/A -	949583	1000 x 10	N/A -	-	-	-

Flextop Tips

► Tips with reduced mounting and ejection force



Description	Length (mm)	In a rack			In sterile rack			In a bag			Individual packaging		
		Cat.No	Pack unit.	Price	Cat.No	Pack unit.	Price	Cat.No	Pack unit.	Price	Cat.No	Pack unit.	Price
30 µl Flextop with ultrafine tip	38.1	949565	96 x 100	N/A -	949566	96 x 100	N/A -	949564	1000 x 10	N/A -	-	-	-
200 µl Flextop with ultrafine tip	49.7	949571	96 x 100	N/A -	949572	96 x 100	N/A -	949570	1000 x 10	N/A -	-	-	-
300 µl Flextop with ultrafine tip	71.1	949555	96 x 48	N/A -	949556	96 x 48	N/A -	949554	1000 x 10	N/A -	-	-	-
200 µl Flextop long with ultrafine tip	83.9	949550	96 x 48	N/A -	949551	96 x 48	N/A -	949549	1000 x 10	N/A -	-	-	-
1250 µl Flextop long with ultrafine tip	88.9	949400	96 x 6	N/A -	949411	96 x 6	N/A -	949389	1000	N/A -	949642	200 x 10	N/A -

SuperSlick Low retention Tips

► Super Low retention Tips

► Suitable for viscous products and proteins

► Available as ZAPSlick with filter (see next page)



Description	Length (mm)	In a rack			In sterile rack			In a bag		
		Cat.No	Pack unit.	Price	Cat.No	Pack unit.	Price	Cat.No	Pack unit.	Price
SuperSlick 10 µl with ultrafine tip	31.4	949415	96 x 12	N/A -	949421	96 x 12	N/A -	949769	1000 x 10	N/A -
SuperSlick 10 µl long with TubeGuard	38.1	949416	96 x 10	N/A -	949422	96 x 10	N/A -	-	-	-
SuperSlick 10 µl extra long	47.6	949776	96 x 100	N/A -	949777	96 x 100	N/A -	949775	1000 x 10	N/A -
SuperSlick 200 µl with bevelled tip	49.7	949418	96 x 10	N/A -	949424	96 x 10	N/A -	949692	1000 x 10	N/A -
SuperSlick 250 µl wide opening	49.7	949773	96 x 100	N/A -	949774	96 x 100	N/A -	949772	1000 x 10	N/A -
SuperSlick 250 µl with ultrafine tip	52.1	949419	96 x 10	N/A -	949425	96 x 10	N/A -	949779	1000 x 10	N/A -
SuperSlick 300 µl with bevelled tip	52.1	949788	96 x 100	N/A -	949789	96 x 100	N/A -	949787	1000 x 10	N/A -
SuperSlick 1250 µl with ultrafine tip	88.9	949420	96 x 6	N/A -	949426	96 x 6	N/A -	949784	1000 x 10	N/A -
SuperSlick Tips for Rainin LTS										
SuperSlick 20 µl for Rainin LTS	48.3	949697	96 x 100	N/A -	949698	96 x 100	N/A -	949696	1000 x 10	N/A -
SuperSlick 250 µl for Rainin LTS	51.3	949701	96 x 100	N/A -	949702	96 x 100	N/A -	949700	1000 x 10	N/A -
SuperSlick 300 µl for Rainin LTS	55.6	949764	96 x 100	N/A -	949765	96 x 100	N/A -	949763	1000 x 10	N/A -
SuperSlick 1000 µl for Rainin LTS	88.9	949705	96 x 100	N/A -	949706	96 x 48	N/A -	949704	1000 x 10	N/A -

Eclipse refill tips

- > Very easy to use charging system
- > Very ecological: the trays are made of organic plastic (petroleum free), low weight of disposable plastic (80% less plastic than usual branded refills)
- > The trays are compatible with other racks of various brands
- > The tray is removed from the tower with a flexible PET lid and simply placed on the rack
- > PET lid keeps the tips clean
- > No contact of the tips with the hands



Description	Length (mm)	In Eclipse refill			In sterile Eclipse refill			In Eclipse mini refill		
		Cat.No	Pack unit.	Price	Cat.No	Pack unit.	Price	Cat.No	Pack unit.	Price
SuperSlik Low retention Tips										
SuperSlik 10 µl with ultrafine tip	31.4	949767	96 x 130	N/A -	-	-	-	949766	96 x 60	N/A -
SuperSlik 200 µl with bevelled tip	49.7	949248	96 x 10	N/A -	-	-	-	-	-	-
SuperSlik 250 µl with ultrafine tip	52.1	949427	96 x 10	N/A -	-	-	-	-	-	-
SuperSlik 1250 µl with ultrafine tip	88.9	949342	96 x 5	N/A -	-	-	-	-	-	-
SuperSlik Low retention Tips for Rainin LTS										
SuperSlik 20 µl for Rainin LTS	48.3	949695	96 x 100	N/A -	-	-	-	-	-	-
SuperSlik 250 µl for Rainin LTS	51.3	949699	96 x 100	N/A -	-	-	-	-	-	-
SuperSlik 300 µl for Rainin LTS	55.6	949762	96 x 80	N/A -	-	-	-	949761	96 x 40	N/A -
SuperSlik 1000 µl for Rainin LTS	88.9	949703	96 x 50	N/A -	-	-	-	-	-	-
Standard Tips										
10 µl with ultrafine tip	31.4	949413	96 x 13	N/A -	-	-	-	949628	96 x 60	N/A -
10 µl long tip and pipette guard	38.1	949132	96 x 14	N/A -	-	-	-	-	-	-
100 µl with bevelled tip for Eppendorf, Yellow	49.7	949110	96 x 10	N/A -	-	-	-	-	-	-
200 µl with yellow bevelled tip	49.7	949092	96 x 10	N/A -	949600	96 x 100	N/A -	949599	96 x 50	N/A -
200 µl with transparent bevelled tip	49.7	949232	96 x 10	N/A -	-	-	-	-	-	-
200 µl with graduated transparent bevelled tip	49.7	949261	96 x 10	N/A -	949714	96 x 100	N/A -	949713	96 x 50	N/A -
200 µl wide opening	49.7	949589	96 x 100	N/A -	-	-	-	-	-	-
250 µl with ultrafine tip	52.1	949285	96 x 10	N/A -	-	-	-	-	-	-
1250 µl wide opening	88.9	949414	96 x 5	N/A -	-	-	-	-	-	-
Tips for Rainin LTS										
20 µl for Rainin LTS	48.3	949543	96 x 110	N/A -	-	-	-	-	-	-
250 µl for Rainin LTS	51.3	949574	96 x 100	N/A -	-	-	-	-	-	-
300 µl for Rainin LTS	55.6	949558	96 x 80	N/A -	949559	96 x 80	N/A -	949557	96 x 40	N/A -
1200 µl for Rainin LTS	88.9	949580	96 x 50	N/A -	-	-	-	-	-	-
Flextop Tips										
200 µl Flextop with ultrafine tip	49.7	949054	96 x 10	N/A -	949568	96 x 100	N/A -	949567	96 x 50	N/A -
300 µl Flextop with ultrafine tip	71.1	949044	96 x 6	N/A -	-	-	-	-	-	-
1250 µl Flextop long with ultrafine tip	88.9	949170	96 x 5	N/A -	949643	96 x 50	N/A -	-	-	-

Refillable hinged lid racks

Cat. No.	Description	Price
949377	Rack for tips 10, 200, 250 µl (10 units)	N/A -
949447	Rack for tips 1000 and 1250 µl (6 units)	N/A -



TIPS
MICROPIPETTES

Labcon filter tips



- Hydrophobic filter to protect micropipettes from aerosols
- In sterile rack, single pack or Eclipse refill
- ZAPSLick low retention versions and/or for Rainin LTS pipettes

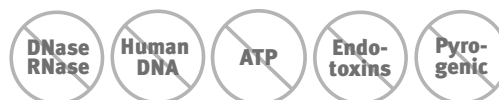

Description	Length (mm)	In sterile rack			Unit packaging			Eclipse UNO refill		
		Cat.No	Pack unit.	Price	Cat.No	Pack unit.	Price	Cat.No	Pack unit.	Price
ZAPSLick Low retention filter tips										
ZapSlik 10 µl	31.4	949791	96 x 120	N/A -	-	-	-	-	-	-
ZapSlik 10 µl long with TubeGuard	38.1	949793	96 x 100	N/A -	-	-	-	-	-	-
ZapSlik 10 µl extra long	47.6	949794	96 x 100	N/A -	-	-	-	-	-	-
ZapSlik 20 µl	49.7	949798	96 x 100	N/A -	-	-	-	-	-	-
ZapSlik 200 µl	52.1	949804	96 x 100	N/A -	-	-	-	-	-	-
ZapSlik 200 µl large orifice	49.7	949740	96 x 100	N/A -	-	-	-	949739	96 x 50	N/A -
ZapSlik 300 µl	52.1	949802	96 x 100	N/A -	-	-	-	-	-	-
ZapSlik 300 µl long	71.1	949741	96 x 6	N/A -	-	-	-	-	-	-
ZapSlik 1000 µl	88.9	949800	96 x 40	N/A -	-	-	-	-	-	-
ZapSlik 1000 µl large orifice	88.9	949743	96 x 40	N/A -	-	-	-	949742	96 x 24	N/A -
ZAPSLick Low retention filter tips for Rainin LTS										
ZAPSLick 20 µl for Rainin LTS	48.3	949734	96 x 100	N/A -	-	-	-	949733	96 x 50	N/A -
ZAPSLick 200 µl for Rainin LTS	51.3	949736	96 x 100	N/A -	-	-	-	949735	96 x 50	N/A -
ZAPSLick 300 µl for Rainin LTS	55.6	949732	96 x 100	N/A -	-	-	-	949731	96 x 50	N/A -
ZAPSLick 1000 µl for Rainin LTS	88.9	949738	96 x 40	N/A -	-	-	-	949737	96 x 24	N/A -
ZAP filter tips										
ZAP 10 µl with scale	49.7	949487	96 x 10	N/A -	-	-	-	-	-	-
ZAP 20 µl bevelled	49.7	949509	96 x 6	N/A -	949491	200	N/A -	949663	96 x 50	N/A -
ZAP 100 µl with graduations	49.7	949726	96 x 100	N/A -	-	-	-	-	-	-
ZAP 50 µl bevelled	49.7	949492	96 x 10	N/A -	-	-	-	-	-	-
ZAP 100 µl bevelled	49.7	949495	96 x 10	N/A -	-	-	-	-	-	-
ZAP 100 µl with graduations	49.7	949498	96 x 10	N/A -	-	-	-	-	-	-
ZAP 100 µl bevelled	49.7	949725	96 x 100	N/A -	-	-	-	-	-	-
ZAP 150 µl bevelled	49.7	949499	96 x 10	N/A -	949501	200	N/A -	-	-	-
ZAP 200 µl bevelled	52.1	949502	96 x 10	N/A -	949477	200	N/A -	949677	96 x 50	N/A -
ZAP 100 µl with ultrafine tip	83.8	949728	96 x 40	N/A -	-	-	-	-	-	-
ZAP 200 µl large bevelled orifice	49.7	949504	96 x 10	N/A -	-	-	-	-	-	-
ZAP 200 µl with ultrafine tip	83.8	949506	96 x 6	N/A -	-	-	-	-	-	-
ZAP 300 µl bevelled	52.1	949508	96 x 10	N/A -	-	-	-	949673	96 x 50	N/A -
ZAP 300 µl with ultrafine tip	71.1	949510	96 x 6	N/A -	-	-	-	-	-	-
ZAP 1000 µl with ultrafine tip	88.9	949511	96 x 6	N/A -	949513	200	N/A -	949525	96 x 24	N/A -
ZAP 1000 µl with FlexTop and ultrafine tip	75.9	949514	96 x 6	N/A -	-	-	-	-	-	-
ZAP 1000 µl with FlexTop and large orifice	88.9	949515	96 x 6	N/A -	-	-	-	-	-	-
ZAP 1200 µl for Sartorius	88.9	949516	96 x 6	N/A -	-	-	-	-	-	-
ZAP filter tips for Rainin LTS										
ZAP 20 µl for Rainin LTS	48.3	949488	96 x 10	N/A -	-	-	-	949752	96 x 50	N/A -
ZAP 200 µl for Rainin LTS	51.3	949507	96 x 10	N/A -	-	-	-	949754	96 x 50	N/A -
ZAP 300 µl for Rainin LTS	55.6	949807	96 x 100	N/A -	-	-	-	949806	96 x 50	N/A -
ZAP 1000 µl for Rainin LTS	88.9	949509	96 x 6	N/A -	-	-	-	949756	96 x 24	N/A -

3D tips



- From a mould selected by the manufacturer
- Adaptable to most existing pipettors
- Bevelled tip for good precision
- In transparent polypropylene

Cat. No.	Volume (µl)	Colour	Sterile	Units/box	Price/box
070010	0.5 - 20	Natural	No	1000	N/A -
070030	100 - 1000	Blue	No	250	N/A -

Special filter tips

Filter tips specially adapted to molecular biology applications (gel) or particular pipette brands.

➤ **Self-sealing anti-contamination filter**

➤ **Sterile on rack**

Cat.No	Volume (µl)	Type	Units/box	Price/box
077051	5	Nanotip for Gilson, Eppendorf, Sartorius Biohitfamily	10 x 96	N/A -
077095	10	For Gilson, Sartorius Biohitfamily	10 x 96	N/A -
07768	10	For LabSystems, Sartorius Biohitfamily	10 x 96	N/A -
077047	10	For Eppendorf	10 x 100	N/A -
077512	100	Special multichannel 50 µl	10 x 96	N/A -
077513	200	Special Gilson, Sartorius Biohitfamily 200 µl	10 x 96	N/A -
077515	200	Extra Long for Eppendorf (90 mm)	8 x 100	N/A -
077539	200	Wide opening, universal	10 x 96	N/A -
077649	1000	Extra-long (88 mm) for Gilson, LabSystems, Sartorius Biohitfamily, Eppendorf	10 x 100	N/A -
077107	1000	Wide opening for cells	10 x 96	N/A -
077204	1200	For Sartorius Biohitfamily Proline 1200 µl	10 x 96	N/A -
077060	10	Gel tip for Gilson	5 x 204	N/A -
077062	20	Gel tip for Gilson, Eppendorf, Sartorius Biohitfamily	5 x 204	N/A -
077068	100	Gel tip for Gilson, Eppendorf, Sartorius Biohitfamily	5 x 204	N/A -
077089	5000	Tip for PIPETMAN® P5000 (in bag)	1 x 100	N/A -

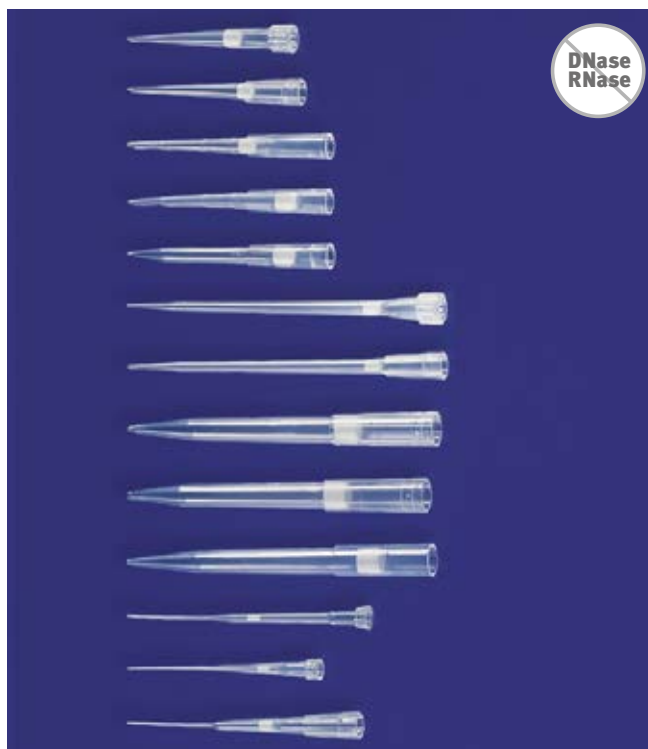

Low volume tips 10 µl

A choice of tips compatible with most brands of micropipettes.

➤ **Very high quality and precision**

➤ **Presentation options**



	Ultra Nanotip 10 µl (1)			Ultra Micro-gel 10 µl (2)			Microtip for Gilson 10 µl (3)			Microtip for Eppendorf 10 µl (4)			Ultra-Micro 10 µl (5)		
Features	Micro-volume tip, graduated to 2.5 µl. For Eppendorf, Gilson, Sartorius Biohitfamily...			Great length tip (58 mm). For Eppendorf, Gilson, Sartorius Biohitfamily			Special Gilson, Sartorius Biohitfamily, LabSystems.			Special Eppendorf, Socorex.			Long Reach tip, for Gilson, Eppendorf, Sartorius Biohitfamily, LabSystems		
	Cat. No.	Units/box	Price/box	Cat. No.	Units/box	Price/box	Cat. No.	Units/box	Price/box	Cat. No.	Units/box	Price/box	Cat. No.	Units/box	Price/box
Bulk	077178	1000	N/A -	077181	1000	N/A -	077185	1000	N/A -	077188	1000	N/A -	077525	1000	N/A -
On rack	077179	10 x 96	N/A -	077182	5 x 204	N/A -	077186	10 x 96	N/A -	077189	10 x 100	N/A -	-	-	-
On sterile rack	077180	10 x 96	N/A -	077183	5 x 204	N/A -	077187	10 x 96	N/A -	077190	10 x 100	N/A -	-	-	-

Special multi-channel tips

300 µl tips on a rack or in strips of 4 for multichannel pipettes. The reinforced rigidity of the rack ensures good stability and avoids deformation when the tips are pushed in.

Suitable for LabSystems, Sartorius Biohitfamily, Eppendorf, Costar.

The flexible 200 µl tip ensures an easy grip without forcing.

Cat. No.	Description	Pack. unit	Price
038064	Tip 300 µl on sterile reinforced rack	10 x 96	N/A -
077528	Tip 300 µl graduated on rack	10 x 96	N/A -
077529	Tip 300 µl graduated on sterile rack	10 x 96	N/A -
077530	Tip 300 µl graduated in bulk	1000	N/A -
022220A	Tip 200 µl flexible on rack	10 x 96	N/A -
022210A	Tip 200 µl flexible on sterile rack	10 x 96	N/A -



Tips for Matrix 1300 µl pipette



Tips specially designed for the Matrix 1300 µl pipette. Volume from 100 to 1300 µl. In bulk or on a rack.

	Bulk	On rack	On rack Sterile
Cat. No.	077563	077564	077565
Units/box	1000	960	960
Price/box	N/A -	N/A -	N/A -

Special tips for Eppendorf



High quality tips, specially designed for Eppendorf micropipettes.

Volume (µl)	In bulk			On a rack			On a sterile rack		
	Cat. No.	Units/box	Price/box	Cat. No.	Units/box	Price/box	Cat. No.	Units/box	Price/box
10	077188	1000	N/A -	077189	10 x 100	N/A -	077190	10 x 100	N/A -
200	077192B	1000	N/A -	077193	10 x 96	N/A -	077194	10 x 96	N/A -
1000	077196	1000	N/A -	077197	10 x 100	N/A -	077198	10 x 100	N/A -
2500	077531	500	N/A -	-	-	-	-	-	-
5000	045530	250	N/A -	045531	10 x 50	N/A -	045532	10 x 50	N/A -

Long tips



Tips compatible with all brands of pipettes.

Their long length allows them to reach the bottom of deep tubes and reduces the risk of contamination.

Volume (µl)	Length (mm)	Compatibility	In bulk			On a rack			On a sterile rack		
			Cat. No.	Units/box	Price/box	Cat. No.	Units/box	Price/box	Cat. No.	Units/box	Price/box
200	90	Universal	077170	1000	N/A -	077171	8 x 204	N/A -	077172	8 x 204	N/A -
1000	88	Universal	077174	1000	N/A -	077175	10 x 100	N/A -	-	-	-
1250	102	Universal	-	-	-	134750	8 x 96	N/A -	134760	8 x 96	N/A -

Special tips for Gilson



Specially designed tips for Gilson PIPETMAN™ and Rainin pipettes.

- ▶ Very high accuracy
- ▶ Perfect fit
- ▶ Natural

Volume	In bulk			On a rack			On a sterile rack		
	Cat. No.	Units/box	Price/box	Cat. No.	Units/box	Price/box	Cat. No.	Units/box	Price/box
10 µl	077185	1000	N/A -	077186	10 x 96	N/A -	077187	10 x 96	N/A -
10 µl long	077525	1000	N/A -	-	-	-	-	-	-
200 µl	015720A	1000	N/A -	032230	10 x 96	N/A -	032250	10 x 96	N/A -
1000 µl	010180	1000	N/A -	010200A	10 x 100	N/A -	010230A	10 x 100	N/A -
5 ml (length 124 mm)	045413	250	N/A -	045414	10 x 50	N/A -	045415	10 x 50	N/A -

Sterile Tips, unit packaging

Gamma sterilised micropipette tips, packed in individual bags.

- Ideal for small pipetting runs
- Risks of contamination completely eliminated
- No autoclaving
- Do not take up space under the hood
- Safety and ease of use



Standard Tips

Cat. No.	Tip	Volume (µl)	Compatibility	Units/box	Price/box
077209	Standard yellow	200	Universal	500	N/A -
077169	Standard blue	1000	Universal	500	N/A -

High precision tips

Free of heavy metals.



Cat. No.	Tip	Volume (µl)	Compatibility	Units/box	Price/box
949472	Yellow	200	Universal	200	N/A -
949473	Natural graduated	200	Universal	200	N/A -
949474	Natural extra-long	1250	Universal	200	N/A -

5 ml and 10 ml tips

5 ml and 10 ml tips for Gilson, Eppendorf and Labsystems.

- In bulk or in refillable rack with lid
- Excellent quality
- With or without filter



Volume	Length (mm)	Without filter - bulk			Without filter - on rack			Without filter - on sterile rack			With Filter - on sterile rack		
		Cat.No	Units/bag	Price/bag	Cat.No	Units/bag	Price/bag	Cat.No	Units/bag	Price/bag	Cat.No	Units/bag	Price/bag
5 ml for Gilson	125	045413	250	N/A -	045414	10 x 50	N/A -	045415	10 x 50	N/A -	045561	10 x 50	N/A -
5 ml for Eppendorf, Sartorius	155	045530	250	N/A -	045531	10 x 50	N/A -	045532	10 x 50	N/A -	045562	10 x 50	N/A -
10 ml for Socorex	165	045564B	200	N/A -	045565	10 x 25	N/A -	048060	10 x 25	N/A -	-	-	-
10 ml for Gilson, Rainin Eppendorf	161	048026B	200	N/A -	048027	10 x 25	N/A -	048028	10 x 25	N/A -	048029	10 x 25	N/A -

Tips for Pipet-Lite Rainin

	20 µl		200 µl		1000 µl	
	Non-sterile	Sterile	Non-sterile	Sterile	Non-sterile	Sterile
Standard without filter						
Cat. No.	-	038373	038375	038377	038380	038381
Units/box	-	960	960	960	800	800
Price/box	-	N/A -	N/A -	N/A -	N/A -	N/A -
Standard with ART filter						
Cat. No.	-	038374	-	038379	-	038382
Units/box	-	960	-	960	-	800
Price/box	-	N/A -	-	N/A -	-	N/A -
Low retention without filter						
Cat. No.	038383	038384	038386	038387	-	-
Units/box	960	960	960	960	-	-
Price/box	N/A -	N/A -	N/A -	N/A -	-	-
Low retention with ART filter						
Cat. No.	-	038385	-	038388	-	038391
Units/box	-	960	-	960	-	800
Price/box	-	N/A -	-	N/A -	-	N/A -

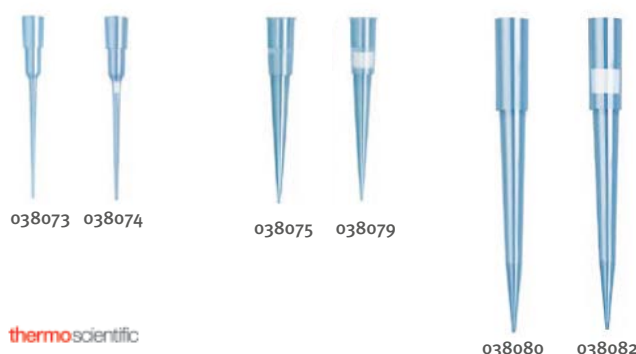

- Specially designed tips for the Rainin Pipet-Lite pipette
- Very low adsorption thin walls
- On rack, with or without ART hydrophobic filter
- Truncated cone tip for effortless attachment and ejection of the tip
- Standard or Low-retention with low surface adhesion

Tips for Rainin LTS



- > 3 types of tips: ART (filtered and sterile) / PURE (sterile) / HLT (non-sterile)
- > For Rainin LTS pipettes
- > Hinged transparent racks with colour inserts associated with the volume
- > Available in 20, 200, 300, 1000 and 1200 µl
- > Available with filters, without filters, in refill systems and in blister packs

Vol. (µl)	Low Retention	Pack. unit	ART		ART refills		PURE		HLT		
			Cat.No.	Price	Cat.No.	Price	Pack. unit	Cat.No.	Price	Cat.No.	Price
20	Yes	10 x 96	038560	N/A -	041545	N/A -	10 x 96	038568	N/A -	038570	N/A -
20	No	10 x 96	038561	N/A -	041546	N/A -	10 x 96	038569	N/A -	038571	N/A -
200	Yes	10 x 96	038562	N/A -	041547	N/A -	10 x 96	038580	N/A -	038582	N/A -
200	No	10 x 96	038563	N/A -	041548	N/A -	10 x 96	038581	N/A -	038583	N/A -
300	Yes	10 x 96	038558	N/A -	041543	N/A -	10 x 96	038572	N/A -	038574	N/A -
300	No	10 x 96	038559	N/A -	041544	N/A -	10 x 96	038573	N/A -	038575	N/A -
1000	Yes	8 x 96	038564	N/A -	041549	N/A -	8 x 96	038584	N/A -	038586	N/A -
1000	No	8 x 96	038565	N/A -	041560	N/A -	8 x 96	038585	N/A -	038587	N/A -
1200	Yes	8 x 96	038566	N/A -	041561	N/A -	-	-	-	-	-
1200	Non	8 x 96	038567	N/A -	041562	N/A -	8 x 96	038577	N/A -	038579	N/A -

Tips for Sartorius Biohitfamily 1200 µl



Special tips for the Sartorius Biohitfamily 1200 µl micropipette.

	Bulk	On a rack	On a sterile rack	Filter on sterile rack
Cat.No.	077200B	077201	077202	077204
Units/box	1000	960	960	960
Price/box	N/A -	N/A -	N/A -	N/A -

Wide-mouth tips for cells and DNA

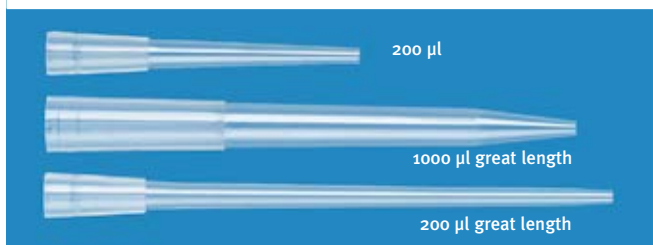

200 µl and 1000 µl wide-mouth tips, especially for fragile cells, DNA and viscous solutions. Ideal for some genomic work.

200 µl standard tips (50 mm)

Cat. No.	Type	Volume (µl)	Units/box	Price/box
077157	Wide opening tip, bulk	200	1000	N/A -
077158	Wide opening tip, on rack 96 tips	200	10 x 96	N/A -

200 µl great length tips (91.2 mm)

Cat. No.	Type	Volume (µl)	Units/box	Price/box
038163	Wide opening tip, on rack 96 tips	200	8 x 96	N/A -
038164	Wide opening sterile tip, on rack 96 tips	200	8 x 96	N/A -

1000 µl great length tips (88 mm)

Cat. No.	Type	Volume (µl)	Units/box	Price/box
077163	Wide opening tip, bulk	1000	1000	N/A -
077164	Wide opening tip, rack 100 tips	1000	1000	N/A -

Multi certified tips



High precision, universal tips, supplied with certificate, certifying per batch:

- sterility achieved by gamma irradiation: SAL of 10^{-3}
- ATP: less than 3.5×10^{-15} g
- DNA: less than 2×10^{-14} g
- RNase: less than 1.1×10^{-11} units Kunitz
- pyrogen: less than 2×10^{-3} EU (test LAL)

- > Packaged on a rack with cover lid
- > Standard or Low Binding version

Vol. (µl)	Type	Standard			Low Binding		
		Cat.No	Units/box	Price/box	Cat.No	Units/box	Price/box
0.1 - 10	GilsonType	023570C	4800	N/A -	035020C	4800	N/A -
0.1 - 10	Microreach Universal	037660C	4800	N/A -	037660TC	4800	N/A -
1 - 200	Universal	-	-	-	035100C	4800	N/A -
1-300	Universa	130930C	4800	N/A -	130930TC	4800	N/A -
100-1000	Universal	-	-	-	035190C	5000	N/A -
50 -1250	Universal	134760C	3840	N/A -	-	-	-

Standard Tips

Cat.No	Vol. (µl)	Colour	Compatibility	Pack. unit	Units/box	Price/box
390980	0 - 200	Yellow	Eppendorf - Brand - Socorex	1000	25000	N/A -
390981	0 - 200	Yellow	Gilson	1000	25000	N/A -
390861	200 - 1000	Blue	Eppendorf - Socorex - HTL - Nichiryo	500	10000	N/A -



ExpellPlus Tips, individually wrapped

- > Sterile
- > Different volumes: 10 µl standard and long, 200 µl and 1000 - 1250 µl
- > Compatible with most brands of pipettes
- > Hydrophobic polymer plastic to reduce sample adhesion



Cat. No.	Volume (µl)	Units/box	Price/box
091248	10	400	N/A -
091249	10 (long version)	400	N/A -
091250	200	400	N/A -
091251	1000	200	N/A -



XL multi-volume Tips

- > One tip for many volumes
- > Scaled to 10, 50, 100, 150 and 200 µl
- > Natural
- > Compatible with most Pipette controllers
- > The non-filter tips are also compatible with 300 µl pipettes
- > Extreme length 91 mm
- > Surface low-binding
- > Examples of PCR inhibitors
- > Sterile version free of pyrogens



Cat. No.	Volume (µl)	Description	Units/box	Price/box
840881	300	Bulk	1000	N/A -
840882	300	Rack	96 x 10	N/A -
840883	300	Rack, sterile	96 x 10	N/A -
840884	200	Rack, sterile, with filter	96 x 10	N/A -



Bevelled tips

Vol. (µl)	Colour	For	Bulk	On a rack	On a sterile rack
Tips, 10 µl					
10	Natural	Gilson, Labsystems Sartorius Biohitfamily	077185	077186	077187
10	Natural	Eppendorf	077188	077189	077190*
Units/box			1000	960	960
Price/box			N/A -	N/A -	N/A -
Tips, 200 µl					
200	Yellow	All brands	-	-	077547B
200	Natural grad.	All brands	077551	-	-
Units/box			1000	-	960
Price/box			N/A -	-	N/A -
Tips, 1000 µl					
1000	Blue	All brands	077553	077554	077555
1000	Natural	All brands	077556	-	077558
Units/box			1000	1000	1000
Price/box			N/A -	N/A -	N/A -

* sold per 1000

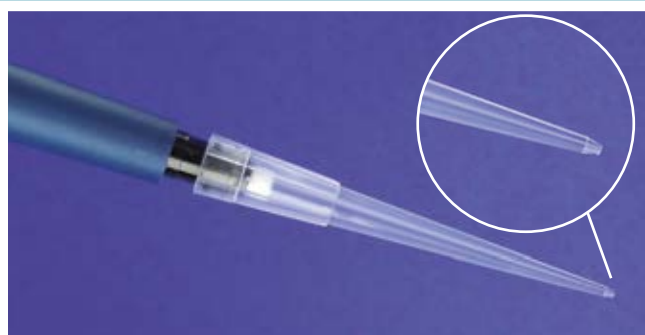

High precision tips with a bevelled end.

- > Increasing the accuracy of the deposit
- > Thin profile
- > In bulk or on a rack with a cover lid



Economical tips for micropipettes

Economical, universal tips suitable for all brands of micropipettes and routine applications. Packaged in bulk (bag).



Cat. No.	Colour	Volume (µl)	For micropipette	Units/bag	Price/bag
391452	Natural	0.5 - 10	Gilson, Sartorius Biohitfamily	1000	N/A -
391453	Natural	0.5 - 10	Eppendorf Research Socorex	1000	N/A -
391454	Natural	2 - 20	Eppendorf Reference	1000	N/A -
391450	Yellow	2 - 200	Universal	1000	N/A -
391455	Yellow	2 - 200	Gilson	1000	N/A -
391456	Natural	2 - 300	Gilson, Finnpiquette Sartorius Biohitfamily	1000	N/A -
391457	Natural	10 - 300	Eppendorf, Gilson Sartorius Biohitfamily	1000	N/A -
391451	Blue	100 - 1000	Gilson, Socorex Sartorius Biohitfamily	1000	N/A -
391458	Blue	1000 - 5000	Gilson, Socorex	250	N/A -
391459B	Natural	1000 - 5000	Eppendorf	250	N/A -
391460	Natural	1000 - 5000	Finnpiquette	250	N/A -
391461	Natural	100 - 10000	Gilson, Socorex, Finnpiquette	100	N/A -

eppendorf

EpT.I.P.S. Tip GELoader 0.5 - 20 µl Eppendorf



Long tapered tip for damage-free gel deposition.

- > For Research plus, Reference and Xplorer micropipettes
- > High accuracy
- > Total length: 62 mm, capillary length: 15 mm
- > Outer ø: 0.3 mm, Inner ø: approx. 0.12 mm
- > Volume: 0.5 - 20 µl
- > Autoclavable (121 °C, 20 min)

Cat. No.	Description	Price the 2 racks of 96
033202	epT.I.P.S. Tip GELoader Eppendorf	N/A -

eppendorf

Capillary tips for FEMTOTIPS micro-injection



Capillaries for microinjection.

Femtotip II: for reproducible injection of adherent and suspension cells; inn ø x out ø: 0.5 x 0.7 µm.

- > Sterile
- > Strictly defined light
- > Fast mounting screws

Cat. No.	Description	Price 20 units
034902	Capillaries Femtotip II	N/A -

eppendorf

Microloader™ Sharp Tip



- > Long filament tip
- > Suitable for loading micro-injection capillaries from the rear
- > Fits on Eppendorf 10 µl pipettes
- > On autoclavable rack

Cat. No.	Description	Price 2 x 96
034903	Microloader Tip	N/A -

DRUMMOND
SCIENTIFIC COMPANY

Capillary micropipettes for PCR



Capillaries equipped with a stainless steel positive displacement piston. In boxes of 100 capillaries + 100 pistons.

- > No aerosol
- > Real sample measurement, independent of viscosity
- > Autoclavable

Cat. No.	Description	Units/ box	Price/ box
075040	Capillary micropipettes for PCR 5 µl	100	N/A -
075041	Capillary micropipettes for PCR 10 µl	100	N/A -

Tips consisting of a reservoir chamber and a capillary.

Applications

- Use of deep tubes
- Gel deposits

Ultra-micro Gel Loading Tips 10 µl for Eppendorf

- Eppendorf, Socorex compatible
- Great length (total: 72 mm, capillary: 25 mm)
- Ø outer exit: 0.61 mm; inner exit Ø: 0.30 mm
- On 204-tip rack



Cat. No.	Description	Packaging	Price
077501	Gel Loading ultra-micro tip	8 racks of 204	N/A -

Ultra-micro Gel Loading Universal Tips, 10 µl

- Compatible with Gilson, Eppendorf, Sartorius Biohitfamily
- Total length: 57 mm; Capillary length: 25 mm
- Ø outer exit: 0.61 mm; inner exit Ø: 0.30 mm



	Bulk	On rack	Sterile on rack	Sterile with filter
Cat. No.	077181	077182	077183	077060
Packaging	1000	5 racks of 204	5 racks of 204	5 racks of 204
Price	N/A -	N/A -	N/A -	N/A -

Gel Saver capillary filament Tips, 10 µl

Ultra pure and flexible capillary. Preserves electrophoresis gels.

- Eppendorf, Socorex compatible
- Total length: 58 mm; Capillary length: 23 mm



Cat. No.	Packing	Price
077503	Rack of 204 tips	N/A -
077504	Rack of 204 sterile tips	N/A -

Gel Saver Tips 200 µl

- Compatible with all brands of 200 µl pipettes
- Total length: 68 mm; Capillary length: 25 mm
- Ø outer exit: 0.61 mm; inner exit Ø: 0.30 mm



Gel Saver tips with filter

Volume (µl)	Packaging	Sterile on rack
1 - 20	Cat. No.	077062
	Price	N/A -
5 - 100	Cat. No.	077068
	Price	N/A -

Gel Saver tips without filter 200 µl. Autoclavable

	On bulk	On rack	Sterile on rack
Cat.No.	077505	077506	077507
Packaging	1000	5 racks of 204	5 racks of 204
Price	N/A -	N/A -	N/A -

Multiflex and Miniflex capillary tips for gel



Fine capillary tips for high precision gel deposition.

- Round-ended tips (ø ext.: 0.57 mm) are particularly suitable for SDS PAGE gels.
- The spatula tips with flat end (ø ext.: 0.17 and 0.37 mm) are indicated for the sequencing gel. The great length tips 200 µl tips (83 mm) allow for use in deep tubes.

► Loaded on an autoclavable rack with a lid for 200 tips



For all brands of 200 µl pipettes

Volume (µl)	Tip	Out. ø (mm)	Length (mm)	On 200-tip rack Non-sterile			On 200-tip rack Sterile		
				Cat. No.	Units/box	Price/box	Cat. No.	Units/box	Price/box
0.5 - 200	Rounded	0.57	83.5	021570	2 X 200	N/A -	013810	4 X 200	N/A -
0.5 - 200	Spatulated flat	0.37	83.5	027600	2 X 200	N/A -	013770	4 X 200	N/A -
0.5 - 200	Spatulated flat	0.17	83.5	017310	4 X 200	N/A -	017320	4 X 200	N/A -



For 10 µl micropipettes Gilson, Sartorius Biohitfamily, Labsystems

Volume (µl)	Tip	Out. ø (mm)	Length (mm)	On 200-tip rack Non-sterile			On 200-tip rack Sterile		
				Cat. No.	Units/box	Price/box	Cat. No.	Units/box	Price/box
0.1 - 10	Rounded	0.57	45	015100	4 X 200	N/A -	015110	4 X 200	N/A -
0.1 - 10	Spatulated flat	0.37	45	015120	4 X 200	N/A -	015130	4 X 200	N/A -
0.1 - 10	Spatulated flat	0.17	45	017350	4 X 200	N/A -	017360	4 X 200	N/A -



For 10 µl Eppendorf micropipettes

Volume (µl)	Tip	Out. ø (mm)	Length (mm)	On 200-tip rack Non-sterile			On 200-tip rack Sterile		
				Cat. No.	Units/box	Price/box	Cat. No.	Units/box	Price/box
0.1 - 10	Spatulated flat	0.37	83.5	-	-	-	013900	4 X 200	N/A -
0.1 - 10	Spatulated flat	0.17	83.5	017330	4 X 200	N/A -	017340	4 X 200	N/A -



Multiflex capillary tip 0.5 - 200 µl bulk

Cat. No.	Description	Units/box	Price/box
028480A	Multiflex Tip 0.5 - 200 µl	1000	N/A -

Extra long 10 µl universal tip

Cat. No.	Description	Units/box	Price/box
077525	Tip, in bulk	1000	N/A -

Long reach tip (44 mm), for Gilson, Eppendorf, Sartorius Biohitfamily, Labsystems. Ideal for micro-volumes in universal molecular biology.



Checkit pipette for checking the accuracy of the micropipette

- Direct reading of pipette accuracy and compliance or not with ISO 8655
- Different versions available for micropipettes from 2 to 200 µl
- Rapid verification of micropipette calibration without the need for a precision balance
- Three checkpoints to cover the range of use of each micropipette



Max. pipette volume (µl)	Measured volume(µl)			Units/box	Cat. No.	Price/box
	100 %	50 %	10 %			
2	2	1	0.2	5	555682B	N/A -
5	5	2.5	0.5	5	555683B	N/A -
10	10	5	1	5	555684B	N/A -
20	20	10	2	5	555685B	N/A -
50	50	25	5	5	555686B	N/A -
100	100	50	10	5	555687B	N/A -
200	200	100	20	5	555688B	N/A -

Universal wall mount

- In ABS
- Accepts all pipette models
- For 2 single-channel pipettes or 2 multi-channel pipettes or a combination of both
- An insert on the top segment can be added or removed to accommodate different pipette widths
- Not autoclavable
- Can be washed with soap and water or standard laboratory disinfectant
- Stand in two different coloured segments for better identification
- Supplied with lower segments: 2 blue, 2 green, 2 transparent; and segment holders: 2 blue, 2 green, 1 purple, 1 yellow

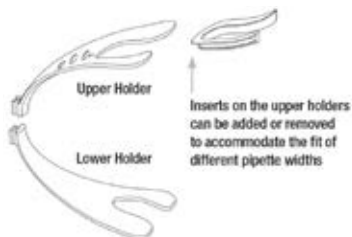

Cat. No.	Description	Units/box	Price/box
320654	Universal wall mount	2	N/A -

Universal rack

- Accepts all pipette models
- In acrylic
- Suitable for multi-channel pipettes



Cat. No.	Description	Price
062935	Rack for 3 pipettes including 1 multichannel pipette	N/A -
062936	Rack for 5 pipettes including 2 multichannel pipettes	N/A -
062937	Rack for 6 pipettes including 4 multichannel pipettes	N/A -

Rack for pipettes and tips

- For 4 pipettes
- Double transparent tray
- Self-closing lid
- Wide edges on the lid for easy handling
- Dimensions: 244 x 165 x 246 mm



Cat. No.	Description	Price
037931	Rack for 4 pipettes and tips	N/A -

Universal carousel rack



- In ABS
- Capacity of 8 single channel or 4 multichannel pipettes - or mixed multichannel and single channel
- Compatible with most pipettes on the market
- Swivel head and weighted base for one-handed operation
- Pipette held vertically
- Different colours available

Colour: upper part of the retention system	Green/blue (8 of each)	Violet/transparent (8 of each)	Transparent (8) and assorted* (8)
Colour: lower part of the retention system	Blue (8)	Violet (8)	Assorted (8)
Cat. No.	320547	320548	320549
Price	N/A -	N/A -	N/A -

* purple, yellow, red, orange, green, grey, blue and transparent

Universal pipette holder, UV decontaminant



- Destroys 99% of contaminants
- UV exposure (254 nm) over 360°
- Capacity of 6 single-channel pipettes
- Compatible with most pipettes on the market

Cat. No.	Description	Price
062984	UV decontamination carousel for single channel pipettes	N/A -

Inclined benchtop rack for micropipettes

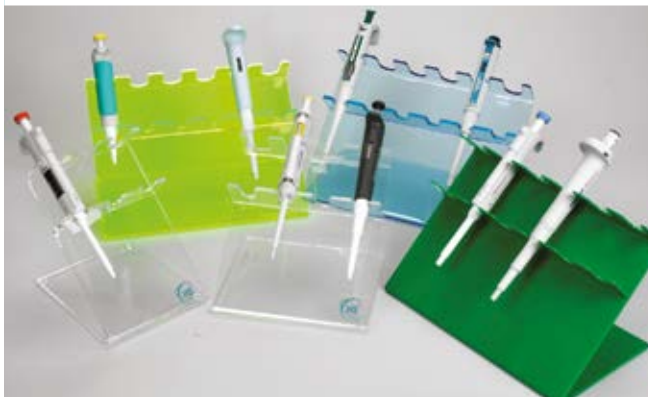

- Practical, universal, economical
- Inclined rack for 2 to 6 micropipettes, to be placed on the bench

Cat. No.	Material	Capacity Pipettes	Dimensions (mm)	Colour	Price
037933	Acrylic	3	NC	Natural	N/A -
037934	Acrylic	4	NC	Natural	N/A -
037551	Acrylic	6	295 x 165 x 195	Natural	N/A -
037937	Acrylic	6	295 x 165 x 195	Blue	N/A -
037552	ABS	6	295 x 165 x 195	Blue	N/A -

Attachable holder for micropipettes



- To be fixed on a shelf or the bench to store 3 micropipettes
- Blue
- Includes 2 holding screws

Cat.No	Description	Price
037548	Holder for 3 micropipettes	N/A -

Carousel rack



- To be placed on a bench or hung under a shelf
- For 12 single-channel pipettes or 3 single-channel and 3 multi-channel pipettes
- Accepts all pipette models
- Dimensions H x W (mm):
- benchtop model: 332 x 193
- model mounted under a shelf: 187 x 193

Colour	Blue	Green	Violet	Price
Cat. No.	320112	320113	320114	N/A -

Stainless steel universal rack

Robust, universal, this inclined rack accepts 5 micropipettes of all brands.
Stainless steel L x W x H (mm): 229 x 146 x 197.

Cat. No.	Description	Price
045868	Stainless steel holder for micropipettes	N/A -



Pipette holders

Universal holder for 7 micropipettes of all brands.

- Your pipettes always at hand
- Elegant and light
- Choice of five colours

Cat. No.	Colour	Price
061005	Light grey	N/A -
061006	Vanilla	N/A -
061007	Ice Blue	N/A -
061008	Mint	N/A -
061365	Pink	N/A -



Stand for pipettes

- Accepts all pipette models (except Eppendorf and Gilson)
- With 5 stations
- Gantry type



Cat. No.	Description	Price
861006B	Rack for micropipettes	N/A -

Carousel rack for 7 PIPETMAN® and other pipettes

Rack for PIPETMAN® and other brands of pipettes.
Capacity: 7 pipettes



Cat. No.	Description	Price
088893	Carousel rack	N/A -

Racks for micropipettes



- Made of epoxy-coated Aluminium
- For storing 10 micropipettes or 5 Pipet-Aid
- L x W x H: 229 x 127 x 171 mm

Cat. No.	Description	Price
045865	Rack for 10 micropipettes	N/A -
045866	Rack for 10 PIPETMAN® Gilson	N/A -

Racks



933908



047039



047020



047134



066088



066089



066090



070998



725620



066798

Eppendorf

Cat.No	Description	Price
933908	Pipette carousel 2 for 6 single or multichannel manual pipettes	N/A -
933909	Charging carousel 2 for 6 pipettes Xplorer® / Xplorer® plus with power adapter	N/A -
933910	Charging rack 2 for 1 pipette Xplorer® / Xplorer® plus without power adapter*	N/A -
933911	Charging rack 2 for 1 pipette Multipette® E3/E3x or stream/Xstream without power adapter*	N/A -
933912	Rack 2 for 1 pipette Multipette® M4	N/A -

* For use with the charger supplied with the pipettes.

Finnpipettes

Cat. No.	Description	Price
047039	Carousel with protective cover	N/A -
047020	Gantry for 5 to 6 Finnpiettes	N/A -
047134	Gantry for 2 to 3 Finnpiettes	N/A -

Gilson

Cat. No.	Description	Price
066088	Carousel for 7 micropipettes PIPETMAN® P, G, Neo	N/A -
066089	Trio rack for Gilson micropipettes	N/A -
066090	Wall-mounted holder for 1 Gilson* micropipette	N/A -
066798	Universal Pipette Rack for multichannel pipettes	N/A -
066817	Carousel for 5 PIPETMAN® M	N/A -

* Supplied with double-sided adhesive tape and screws for wall mounting.

Sartorius Biohitfamily

Cat. No.	Description	Price
070998	Carousel for 6 mLine micropipettes or 6 micropipettes Tacta Sartorius Biohitfamily	N/A -
725620	Linear rack for 11 to 13 (on 2 sides) micropipettes Sartorius Biohitfamily	N/A -

Socorex

Cat. No.	Description	Price
061692	Adhesive holder for 2 pipettes	N/A -
061257	Holder 340 for 3 microdispensers	N/A -

Varipette® Eppendorf

Pipette for large volumes from 1 to 10 ml
Positive displacement micropipette for volumes up to 10 ml. Well suited for viscous liquids and high vapour pressure. The Varipette® accepts two types of dispensing syringes:

- the Varitip P syringe for aspirating volumes of 1 to 10 ml into short containers;
- the Varitip S, consisting of a short syringe and a long Maxitip tip of 10 ml (to be ordered separately), is used to aspirate liquids from the bottom of deep vials or tubes. A special valve can also be added to prevent droplets from forming on the tip with liquids with high vapour pressure.



Cat. No.	Description	Units/box	Price/box
033067	Varipette 10 ml 4720	1	N/A -
033068	Syringes Varitip P	100	N/A -
033069	Syringes Varitip S	30	N/A -
033070	Maxitip 10 ml for Varitip S	200	N/A -
033072	Valve for Varitip S	100	N/A -
033073	Adapter for Eppendorf Carousel Rack	1	N/A -

Positive displacement pipettes Transferpettor BRAND

Transferpettor pipettes - variable volume

Volume (µl)	Increment (µl)	Colour	Cat. No.	Price	Spare parts					
					Capillaries		Piston		Piston rod	
					Cat. No.	Price	Cat. No.	Price	Cat. No.	Price
2.5 - 10	0.01	Orange	781931	N/A -	042407	N/A -	-	-	781965	N/A -
5 - 25	0.1	White	674331	N/A -	090618	N/A -	701920	N/A -	781966	N/A -
10 - 50	0.1	Green	674332	N/A -	781695	N/A -	781694	N/A -	781967	N/A -
20 - 100	0.1	Blue	781652	N/A -	674328	N/A -	781953	N/A -	781968	N/A -
100 - 500	1	Green	781932	N/A -	781949	N/A -	781954	N/A -	-	-
200 - 1000	1	Yellow	781650	N/A -	781757	N/A -	781758	N/A -	-	-
1000 - 5000	10	Red	7028-10	N/A -	781951	N/A -	781955	N/A -	-	-
2000 - 10000	10	Orange	781651	N/A -	781952	N/A -	781957	N/A -	-	-

Designed for liquids with high or low viscosity, high density, high vapour pressure and a tendency to foam.

Transferpettor pipettes - fixed volume

Volume (µl)	Colour	Cat. No.	Price	Spare parts					
				Capillaries		Piston		Piston rod	
				Cat. No.	Price	Cat. No.	Price	Cat. No.	Price
1	White	781933	N/A -	042406	N/A -	-	-	781964	N/A -
2	White	781934	N/A -	042406	N/A -	-	-	781964	N/A -
5	White	781935	N/A -	042406	N/A -	-	-	781964	N/A -
10	Orange	781937	N/A -	042407	N/A -	-	-	781965	N/A -
20	Black	781938	N/A -	091499	N/A -	701920	N/A -	781966	N/A -
25	White	781939	N/A -	090618	N/A -	701920	N/A -	781966	N/A -
50	Green	781943	N/A -	781695	N/A -	781694	N/A -	781967	N/A -
100	Blue	781403	N/A -	674328	N/A -	781953	N/A -	781968	N/A -
200	Red	781409	N/A -	674328	N/A -	781953	N/A -	781969	N/A -

Accessories

Cat. No.	Description	Price
781962	Rack for 4 pipettes up to 200 µL	N/A -
781963	Rack for 2 pipettes from 0.5 to 10 mL	N/A -



MICROMAN® E Gilson



Positive displacement micropipettes with disposable capillary pistons (CPs), particularly suitable for difficult liquids.

- ▶ Ideal for viscous, volatile, dense, contaminated or hazardous samples
- ▶ Elimination of any risk of contamination by aerosols (disposable CPs)
- ▶ Available with ISO 17025 calibration certificate (COFRAC approved)

▶ MICROMAN® E

- ▶ “QuickSnap” device: attaches the CP as easily as a standard pipette tip
- ▶ Volume locking system for precise adjustment without risk of change
- ▶ Display in front position
- ▶ New shape and large push button

Type	Volume	Cat. No.	Price
		MICROMAN E*	
M10	1 - 10 µl	070089	N/A -
M25	3 - 25 µl	070090	N/A -
M50	20 - 50 µl	070091	N/A -
M100	10 - 100 µl	070092	N/A -
M250	50 - 250 µl	070093	N/A -
M1000	100 - 1000 µl	070094	N/A -

Capillary-Piston Assembly (CP)

- ▶ Very high accuracy for difficult samples
- ▶ CP10 and CP100 models are autoclavable
- ▶ On rack and in bulk, depending on the model
- ▶ RNase, DNase, DNA, and protease free for sterile models

Volume (µl)	Type	for Microman	Cat.No.	Sterile	on rack	Units/box	Price/box
1 - 10	CP10	M10	066115	No	Yes	192	N/A -
	CP10	M10	066116	No	Yes	960	N/A -
	CP10ST	M10	066117	Yes	Yes	192	N/A -
	CP10ST	M10	066118	Yes	Yes	960	N/A -
3 - 25	CP25	M25	067494	No	Yes	960	N/A -
	CP25	M25	066119	No	No	200	N/A -
20 - 50	CP50	M50	067495	No	Yes	960	N/A -
	CP50	M50	066120	No	No	200	N/A -
10 - 100	CP100	M100	066121	No	Yes	192	N/A -
	CP100	M100	066122	No	Yes	960	N/A -
	CP100ST	M100	066123	Yes	Yes	192	N/A -
	CP100ST	M100	066124	Yes	Yes	960	N/A -
50 - 250	CP250	M250	067496	No	Yes	960	N/A -
	CP250	M250	066125	No	No	200	N/A -
100 - 1000	CP1000	M1000	066414	No	Yes	182	N/A -
	CP1000ST	M1000	066222	Yes	Yes	182	N/A -

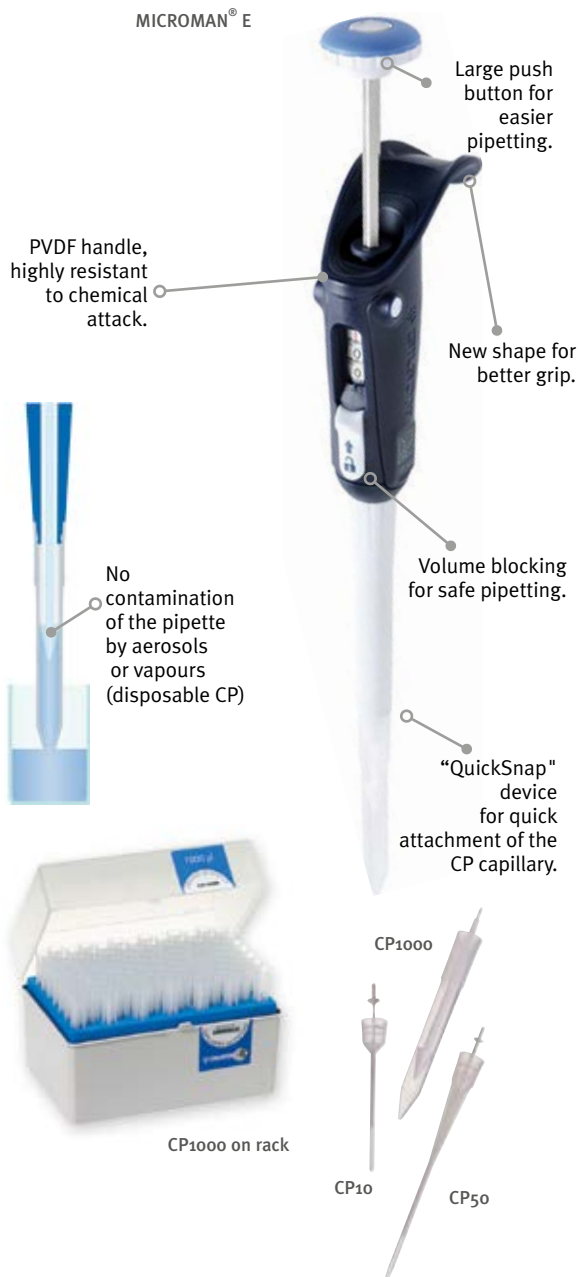

Acura® capillar 846 positive displacement micropipette



- ▶ Tapered shape, ergonomic finger rest
- ▶ Soft activation of the piston
- ▶ Reliable volume selection, each pipette has 5 easily selected fixed volumes
- ▶ Colour coding on pipette, plunger and capillary tube
- ▶ Stainless steel/PTFE piston



Acura micropipette® capillar 846			Capillary tubes			Spare pistons		
Cat. No.	Volume (µl)	Price	Cat. No.	Units/box	Price/box	Cat.No	Units/box	Price/box
061945	1-2-4-5	N/A -	061241	200	N/A -	061246	5	N/A -
061946	5-10-15-20-25	N/A -	061242	200	N/A -	061247	5	N/A -
061947	10-20-30-40-50	N/A -	061243	200	N/A -	061248	5	N/A -
061948	60-75-80-90-100	N/A -	061244	200	N/A -	061249	5	N/A -
061949	100-120-150-175-200	N/A -	061245	100	N/A -	061250	5	N/A -

Support

Cat. No.	Description	Price
061257	Holder for 3 micropipettes	N/A -

Micropipette Multipette® M4 Eppendorf

Manual reagent dispenser using Combitips® Advanced syringes. For precise dispensing of all types of liquids without the risk of aerosol contamination.

- Simple and error-free handling
- Automatic recognition of the Combitip with display of the selected volume
- Dispensing counter displayed on the screen
- Wide range of dispensing volumes with 9 Combitip sizes from 1 µl to 10 ml
- 20 volume choices per Combitip: 112 volumes available
- Ejecting the Combitip using the dispensing trigger
- Volume selection with the thumb
- Optimized grip to fit all body types, suitable for both left and right handed users
- 20% less weight than the Multipette® Plus

Cat. No.	Description	Price
933049	Multipette® M4 with holder (wall-mounted, for pipettes)	N/A -
933050	Multipette® M4 Starter Kit: Multipette® M4, Combitip Rack, Combitip, with holder (wall and/or carousel)	N/A -
933039	Eppendorf TrackIT includes software and an RFID reader	N/A -
045322	Battery for Multipette®	N/A -



Multipette® M4 with wall bracket

Micropipette Multipette® electronic E3 / E3x Eppendorf

Programmable, multi-functional, electronic positive displacement pipettes. 2 models:

- Multipette® E3: for standard applications (pipetting, dispensing and automatic dispensing)
- Multipette® E3x: in addition to standard applications, aspiration/dispensing, supernatant aspiration, titration, sequential dispensing

- Positive displacement operation
- Application selection wheel, quick setting buttons for parameters
- Automatic volume display with automatic recognition of the Combitip® Advanced
- Over 2500 volumes available from 1 µl to 50 ml
- Ejection of the Combitip by separate button
- Supplied with charger, Li-ion battery and EN ISO 8655 certificate of conformity
- Memorization of 5 most common protocols
- Warranty: 2 years



Cat. No.	Description	Price
933170	Multipette® E3, with charger and assortment of Combitips® Advanced	N/A -
933171	Multipette® E3x, with charger and assortment of Combitips® Advanced	N/A -
933172	Multipette® E3, with charging rack 933911 and assortment of Combitips® Advanced	N/A -
933173	Multipette® E3x, with charging rack 933911 and assortment of Combitips® Advanced	N/A -

ViscoTip 10 ml Eppendorf

Specially designed for handling high viscosity liquids, such as glycerine 99.5%, Tween, oils, creams.

- For liquids with a viscosity between 200 mPa.s and 14 000 mPa.s
- Volume: 10 ml
- Volume min/max: 10 - 10000 µl
- Colour coded: double Orange

Cat. No.	Description	Units/box	Price/box
934187	ViscoTip 10 ml Eppendorf	100	N/A -



eppendorf

Combitips® Advanced Eppendorf



Compatible with: Multipette® Plus 4980 and 4981, Multipette® Stream and Xstream, Multipette® Pro, EDOS 5222, Multipette® 4780.

Available in:

- standard quality per 4 bags of 25 pieces
- PCR clean per 4 bags of 25 pieces
- Biopur quality, individually blister-packed, guaranteed sterile, pyrogen-free, DNA-free, ATP-free and RNase-free
- Forensic DNA quality: ISO 18385 certified, free of human DNA, DNase, RNase and PCR inhibitor

► **9 sizes of Combitips® Advanced:** volumetric range from 0.1 to 50 ml

► **Colour coding for quick identification of the desired Combitips®**, without errors

► **Long, tapered tips:** the 2.5 - 5 and 10 ml models reach the bottom of the tubes, allowing them to be emptied so that no sample is lost

► **Practical:** delivered in a package with a servant

► **Option:** Combitip Rack for one-handed operation

Vol. (ml)	With Multipette® M4			With Multipette® E3 / E3X			Colour code	Combitips® Advanced							
	Volume Min/Max	Increment (µl)	Max. volume dispensed	Volume Min/Max	Increment (µl)	Max. volume dispensed		Standard		PCR Clean		Biopur		Forensic DNA	
								Cat.No	Price/100 units	Cat.No	Price/100 units	Cat.No	Price/100 units	Cat.No	Price/100 units
0.1	1 - 20 µl	1 µl	20 µl	1 - 100 µl	0.1 µl	0.1 ml	White	033082B	N/A -	035746	N/A -	033091B	N/A -	-	-
0.2	2 - 40 µl	2 µl	40 µl	2 - 200 µl	0.2 µl	0.2 ml	Light blue	033083B	N/A -	035747	N/A -	033092B	N/A -	-	-
0.5	5 - 100 µl	5 µl	100 µl	5 - 500 µl	0.5 µl	0.5 ml	Violet	033084B	N/A -	035748	N/A -	033093B	N/A -	-	-
1	10 - 200 µl	10 µl	200 µl	10 µl - 1 ml	1 µl	1 ml	Yellow	033085B	N/A -	035749	N/A -	033094B	N/A -	933920	N/A -
2.5	25 - 500 µl	25 µl	500 µl	25 µl - 2.5 ml	2.5 µl	2.5 ml	Green	033086B	N/A -	035750	N/A -	033095B	N/A -	933921	N/A -
5	50 - 1000 µl	50 µl	1000 µl	50 µl - 5 ml	5 µl	5 ml	Blue	033087B	N/A -	035751	N/A -	033096B	N/A -	933922	N/A -
10	100 - 2000 µl	100 µl	2000 µl	100 µl - 10 ml	10 µl	10 ml	Orange	033088B	N/A -	035752	N/A -	033097B	N/A -	-	-
25	250 - 5000 µl	250 µl	5000 µl	250 µl - 25 ml	25 µl	25 ml	Red	033089B	N/A -	035753	N/A -	033098B	N/A -	-	-
50	500 - 10000 µl	500 µl	10000 µl	500 µl - 50 ml	50 µl	50 ml	Grey	033090B	N/A -	035754	N/A -	033099B	N/A -	-	-

Packaging with dispenser



Accessories

Cat. No.	Description	Colour	Units/box	Price/box
033100B	Combitips® Advanced Adapter 25 ml	Red	1	N/A -
033101B	Combitips® Advanced Adapter 50 ml	Light grey	1	N/A -
033102B	Combitips® Advanced Biopur Adapter 25 ml, sterile	Red	7	N/A -
033103B	Combitips® Advanced Biopur Adapter 50 ml, sterile	Light grey	7	N/A -
033106B	Combitip Rack with lid for 8 Combitips® Advanced from 0.1 to 10 ml		1	N/A -

Finnpipette Multistepper

8-channel pipette for repetitive delivery of reagents to microplates. Each tip has a capacity of 1500 µl, allowing distribution in rows of 8 wells of 24 x 50 µl, 12 x 100 µl, 8 x 150 µl, 6 x 200 µl or 5 x 250 µl.

► **Maximum volume:** 1250 µl

► **Increment:** 50 µl

Finntips 50 - 1500 µl Multistepper

Cat.No	Description	Units/box	Price/box
047170	Finntips, in bulk	400	N/A -
047171	Finntips, in rack	10 x 96	N/A -
047172	Finntips, sterile on rack	10 x 96	N/A -





DISTRIMAN® Gilson



Positive displacement repetitive dispensing pipette.
Dispenses volumes from 1 µl to 1000 µl with three DistriTips syringes.

- Up to 125 aliquots per DistriTips
- Without conversion table: simply display the volume of the Distritip and the volume to be delivered on the DISTRIMAN®
- DistriTips are free of RNase, DNase, DNA, RNA and proteases
- Standard or sterilised DistriTips in individual packaging

DISTRIMAN® Gilson

Cat. No.	Description	Price
066134	DISTRIMAN® Gilson	N/A -

DistriTips Gilson

Cat. No.	Model	Total volume	Sterilised	Dispensed volume	Units/box	Price/box
066135	Micro	125 µl	No	1 µl to 12.5 µl	50	N/A -
066136	Mini	1250 µl	No	10 µl to 125 µl	50	N/A -
066137	Maxi	12.5 ml	No	100 µl to 1.25 ml	50	N/A -
066138	Micro	125 µl	Yes*	1 µl to 12.5 µl	50	N/A -
066139	Mini	1250 µl	Yes*	10 µl to 125 µl	50	N/A -
066140	Maxi	12.5 ml	Yes*	100 µl to 1.25 ml	50	N/A -

* Unit packaging



Adjustable repeating pipette Stepper 416

- Dispenses up to 73 doses of volumes ranging from 10 µl to 5 ml without thumb input
- Adjustment knobs indicating the number of doses and the volume
- A locking mechanism prevents dispensing errors when the syringe is almost empty
- Supplied with three volumes of Ecostep syringes to cover the range from 10 µl to 5 ml
- Warranty: 2 years

Cat. No.	Description	Price
350413	Stepper 416 delivered with 3 colour coded selector buttons, adapter and sample Ecostep syringes	N/A -
061010	Transparent stand for Stepper	N/A -
061011	Extra adapters for red Ecostep syringe (5 units)	N/A -



Ecostep syringes



Two presentations:

- Ecostep syringes in bulk, non-sterile;
- Ecostep syringes, sterile Bioproof™ certified free of human DNA, DNase, RNase and pyrogen (endotoxin) - individual certificate sent on request.

Volume	Knob colour	In bulk		Sterile, individual packaging	
		Cat. No.	Price the box of 100*	Cat. No.	Price the box of 50*
0.75 ml	Yellow	985184	N/A -	985185	N/A -
3.75 ml	Blue	985186	N/A -	985187	N/A -
37.5 ml	Red	985188	N/A -	985189	N/A -
0.75 / 3.7 and 37.5 ml	Yellow, blue and red	350352*	N/A -	350353*	N/A -

* Assortment of the 3 volumes - price for the box of 60.

Dispenser Tips 3D



The 3D Dispenser Tips are used for repetitive dispensing of volumes between 10 µl and 5 ml and are perfectly suited to the Eppendorf Multipipette 4780. They are available in six volumes: 0.5 ml, 1.25 ml, 2.5 ml, 5 ml, 12.5 ml, 25 ml and 50 ml, in sterile single pack or non-sterile versions. The 3D Dispenser Tips are made of polypropylene and are graduated.

Cat. No.	Volume (ml)	Sterile	Pack unit.	Units/box	Price/box
070501	0.5	No	50	100	N/A -
070511	0.5	Yes	1	100	N/A -
070502	1.25	No	50	100	N/A -
070512	1.25	Yes	1	100	N/A -
070503	2.5	No	50	100	N/A -
070513	2.5	Yes	1	100	N/A -
070504	5	No	50	100	N/A -
070514	5	Yes	1	100	N/A -
070505	12.5	No	25	100	N/A -
070515	12.5	Yes	1	100	N/A -
070507	25	No	25	25	N/A -
070517	25	Yes	1	25	N/A -
070506	50	No	5	25	N/A -
070516	50	Yes	1	25	N/A -

Adapters

Cat. No.	Description	Price
071386	Adapter 50 ml	N/A -

Variable volume microdosing pipettes Acura® 865 Socorex



Microdosing pipettes for continuous dosing of microvolumes.

- ▶ Three-way valve for automatic liquid filling
- ▶ 3 models in a volume range from 5 to 2000 µl
- ▶ Fully autoclavable at 121 °C
- ▶ Serial number and individual calibration certificate
- ▶ Multiple power supply options (see accessories)
- ▶ Supplied with 90 cm silicone hose, foam cannula, valve cap, test certificate and instructions for use

Cat. No.	Volume (µl)	Division (µl)	Price
061370	5 - 50	0.1	N/A -
061371	20 - 200	0.2	N/A -
061372	100 - 1000	1.0	N/A -

Dispensing pipettes HandyStep® S et HandyStep® Touch

HandyStep® S

Positive displacement operation.
Supplied with quality certificate and wall mount.

➤ **Complies with the CE/IVD directive**

Cat. No.	Description	Price
705100	HandyStep® S with wall bracket	N/A -
091434	Wall bracket for HandyStep® S	N/A -

HandyStep® Touch and Touch S

2 versions:

- **HandyStep® Touch:** pipetting, multi-dispensing and automatic dispensing functions;
- **HandyStep® Touch S:** all functions of the HandyStep® Touch, as well as sequential dispensing, multi-suction and titration.

➤ **Touch screen with intuitive interface**

➤ **Automatic detection of DD-Tips II**

➤ **Automatic tip ejection**

➤ **Smooth surfaces without grooves or corners for easy cleaning**

➤ **Induction charging**

Cat. No.	Description	Price
042443	Handystep® Touch complete	N/A -
042444	Handystep® Touch S complete	N/A -
090257	Handystep® Touch with charging rack	N/A -
090258	Handystep® Touch S with charging rack	N/A -
042445	Charging rack without power adapter	N/A -
042446	Support rack	N/A -
042447	Universal power adapter	N/A -
042448	Universal shelf and rack support	N/A -
042449	Spare battery	N/A -



HandyStep® DD-tips II Dispensing tips

Vol. (ml)	Non-sterile			BIO-CERT*		
	Cat.No	Units/box	Price/box	Cat.No	Units/box	Price/box
0.1	042450	100	N/A -	042460	100	N/A -
0.5	042451	100	N/A -	042461	100	N/A -
1	042452	100	N/A -	042462	100	N/A -
1.25	042453	100	N/A -	042463	100	N/A -
2.5	042454	100	N/A -	042464	100	N/A -
5	042455	100	N/A -	042465	100	N/A -
10	042456	100	N/A -	042466	100	N/A -
12.5	042457	100	N/A -	042467	100	N/A -
25	042458	50	N/A -	042468	25	N/A -
50	042459	25	N/A -	042469	25	N/A -

* Sterile, RNase free, DNA free, endotoxin free, ATP free

Cat.No	Description	Price
042470	Set of 20 tips vol. 0.5 / 1 / 1.25 / 2.5 / 5 / 10 and 12.5 ml	N/A -

Dispensing pipette Corning® Step-R



Corning®
Step-R



StarterKit



004218

006620



- ▶ Repeater pipette suitable for pipetting and dispensing viscous or volatile liquids
- ▶ Wide range of dispensing volumes with 8 syringe sizes from 0.05 to 50 ml
- ▶ With visual display of dispensed volumes and syringe volumes on the pipette body
- ▶ Lightweight, convenient to use
- ▶ Robust, maintenance-free
- ▶ Available as a Starter Kit, with Corning® Step-R pipette, two adapters 25 and 50 ml, 5 syringes of volumes 0.05; 2.5; 5 and 12.5 ml, as well as 2 syringes of volumes 25 and 50 ml
- ▶ Requires the addition of an adapter for 25 and 50 ml syringes

Cat. No.	Description	Price
004217	Corning® Step-R	N/A -
006636	Corning® Step-R Starter Kit	N/A -

Accessories

Cat. No.	Description	Price
004218	Adapter for 25 ml syringe	N/A -
004219	Adapter for 50 ml syringe	N/A -

Syringes for Corning® Step-R

- ▶ Positive displacement polypropylene syringes
- ▶ Sterile syringes are certified free of DNase, RNase, pyrogens and ATP

Vol. (ml)	Non-sterile Syringes			Sterile syringes		
	Cat.No	Units/box	Price/box	Cat.No	Units/box	Price/box
0.05	006620	100	N/A -	006628	100	N/A -
0.5	006621	100	N/A -	006629	100	N/A -
1.25	006622	100	N/A -	006630	100	N/A -
2.5	006623	100	N/A -	006631	100	N/A -
5	006624	100	N/A -	006632	100	N/A -
12.5	006625	100	N/A -	006633	100	N/A -
25	006626	25	N/A -	006634	25	N/A -
50	006627	25	N/A -	006635	25	N/A -



Ripette®



Dispensing pipette for dispensing up to 48 doses from 1 µl to 5 ml. For use with Ritips®, Dispenser Tips and Combitips. Practical, comfortable, light (100 g).

- ▶ Easily adjustable dispensing volumes and doses (see table)
- ▶ Maintenance free
- ▶ Different colours

Cat.No	Description	Price
070539	Ripette®	N/A -
070539P	Ripette® - Pink	N/A -
070539G	Ripette® - Grey	N/A -
070539B	Ripette® - Blue	N/A -

TIPS	NO	1	2
0.05 ml	1	1	2
0.5 ml	10	20	
1.25 ml	25	50	
2.5 ml	50	100	
5.0 ml	100	200	
12.5 ml	250	500	
25 ml	500	1000	
50 ml	1000	2000	



Ripette® Pro



- ▶ Convenient to use, improved ergonomics: good grip, lightweight
- ▶ With visual panel on the pipette showing all volumes to be dispensed according to the volume of the dispensing syringe
- ▶ Compatible with Ritips and other syringes
- ▶ Fits 12 sizes of dispensing syringes
- ▶ 10 sampling programs, 120 volume combinations per syringe
- ▶ Robust, maintenance-free

Cat.No	Description	Price
070888	Ripette® Pro	N/A -



Ritips® Evolution and Ritips® standard

- Universal dosing tips
- Guarantee a safe and reproducible result
- Bioclean version: sterile, individually wrapped, free of pyrogens, ATP, RNase and DNA

Ritips® Evolution

- Compatible with Ripette, Ripette pro, Ripette genX, eLine Dispenser, Multipette 4780, Multipette plus, Multipette M4, Minilab 100, Minilab 101, Minilab 201, Distriman, StepMate, EasyStep, EasyStep electronic, RepeatOne, Handrop, HandyStep, HandyStep S, HandyStep electronic
- The display remains inactive when used with the Multipette plus, Multipette M4

Volume (ml)	Ritips® Evolution non sterile			Ritips® Evolution sterile		
	Cat.No	Units/box	Price/box	Cat.No	Units/box	Price/box
0.1	070520D	100	N/A -	070529B	100	N/A -
0.2	070521D	100	N/A -	070530B	100	N/A -
0.5	070522D	100	N/A -	070531B	100	N/A -
1	070523D	100	N/A -	070532B	100	N/A -
2.5	070524D	100	N/A -	070533B	100	N/A -
5	070525D	100	N/A -	070534B	100	N/A -
10	070526D	100	N/A -	070535B	100	N/A -
25	070527D	25	N/A -	070536B	25	N/A -
50	070528D	25	N/A -	070537B	25	N/A -



Ritips® Evolution Adapters

Cat. No.	Description	Price
071466	Adapter for Ritips® Evolution 25 ml	N/A -
071467	Adapter for Ritips® Evolution 50 ml	N/A -

Ritips® standard

- Compatible with Ripette®, Ripette® pro, Multipette 4780, eLine-Dispenser, Minilab 100, Minilab 101, Minilab 201, Distriman, Repetman, StepMate, EasyStep, EasyStep electronic, RepeatOne, Handrop.

Volume (ml)	Ritips® standard, non sterile			Ritips® standard, sterile		
	Cat.No	Units/box	Price/box	Cat.No	Units/box	Price/box
0.05	070544B	100	N/A -	071387	100	N/A -
0.5	070545	100	N/A -	070552	100	N/A -
1.25	070546B	100	N/A -	070553B	100	N/A -
2.5	070547	100	N/A -	070554	100	N/A -
5	070548	100	N/A -	070555	100	N/A -
12.5	070549B	100	N/A -	070556B	100	N/A -
25	070560	25	N/A -	070557	25	N/A -
50	070551	25	N/A -	-	-	-



Adapters for Ritips® standard

Cat. No.	Description	Price
071386	Adapter for Ritips® standard 50 ml	N/A -

Benchtop One Touch Pipette controller 20 and 250 µl



- ▶ Semi-automatic pipettor for 96 or 384 well plates (requires adapter to be ordered separately)
- ▶ For liquid transfer from 1 to 20 µl or 5 to 250 µl depending on the model
- ▶ Intuitive control with rotary knob to set function, volume and dispensing speed
- ▶ Function: suction, dispensing, mixing, recordable programs
- ▶ Platform to accommodate a rack of tips and 2 plates, easy transfer from one plate to another
- ▶ For use with One Touch tips

▶ Technical specifications

Weight (kg)	9.5
Operating temperature	10 - 37 °C
Model 10/20 µl	
Accuracy	< 3 % (5 to 20 µl); < 5 % (1 to 5 µl)
Uncertainty	+/- 3 % (5 to 20 µl); +/- 3 % (1 to 5 µl)
Resolution	0.1 or 1 µl en using the adjustment knob
Volume range	1 µl - 20 µl
Dimensions W x L x H (cm)	21.6 x 45.7 x 43.2
Model 250 µl	
Accuracy	< 2 % (25 to 250 µl); < 5 % (5 to 20 µl)
Uncertainty	+/- 3 % (25 to 250 µl); +/- 5 % (5 to 20 µl)
Resolution	1 or 5 µl en using the adjustment knob
Volume range	5 µl - 250 µl
Dimensions W x L x H (cm)	21.6 x 45.7 x 43.2

One Touch bi-component tips on plastic rack

Cat. No.	Description	Compatible with pipettor	Price the 10 x 96
010330	One Touch Tip 330 µl, non sterile	250 µl	N/A -
010340	One Touch Tip 330 µl, sterile	250 µl	N/A -
010350	One Touch Tip 300 µl, sterile, with filter	250 µl	N/A -
010300	One Touch Tip 10/20 µl, non sterile	10/20 µl	N/A -
010310	One Touch Tip 10/20 µl, sterile	10/20 µl	N/A -
010320	One Touch Tip 10/20 µl, sterile, with filter	10/20 µl	N/A -

Cat. No.	Description	Price
014903	Pipettor Benchtop Mmulti 10/20 µl	N/A -
014901	Pipettor Benchtop Mmulti 250 µl	N/A -

Accessory

Cat. No.	Description	Price
014905	Tray for use with 384-well plate	N/A -

96-channel Benchtop Pipettor Liquidator 96™

RAININ
Pipetting 360°



Innovative benchtop manual pipetting system that allows 96 samples to be processed at once and provides 4 positions for continuous use.

- ▶ Flexible operation
- ▶ No programming
- ▶ Immediate results
- ▶ Unique manual pipetting system for medium to high flow applications
- ▶ Minimal space requirement, compatible with any bench top or laminar flow hood
- ▶ Compatibility with 96-well and 384-well plates

▶ Technical specifications

Volume range	5 to 200 µl, 1 µl increments
Immersion depth	Adjustable for each position
Small footprint	0.25 m ²
Weight	14 kg
Dimensions	38 x 41 x 33 cm

Cat. No.	Description	Price
712821	Manual pipettor Liquidator 96™ 0.5 to 20 µl	N/A -
712152	Manual pipettor Liquidator 96™ 5 to 200 µl	N/A -
712149	Height adjustment rods	N/A -
712154	Adapter for 384-well plate	N/A -

Tips for Liquidator

Vol.	Units/box	Tips for Liquidator standard version						Tips for Liquidator Low retention version					
		Rack with removable lid		Rack with removable sterile lid		With filter, rack with removable sterile lid		Rack with removable sterile lid		With filter, rack with removable sterile lid		SpaceSaver	
		Cat.No	Price/box	Cat.No	Price/box	Cat.No	Price/box	Cat.No	Price/box	Cat.No	Price/box	Cat.No	Price/box
20 µl	10 x 96	17011185	N/A -	712899	N/A -	-	-	712364	N/A -	712365	N/A -	712368	N/A -
200 µl	10 x 96	712146	N/A -	712147	N/A -	712148	N/A -	712366	N/A -	712367	N/A -	712369	N/A -

EpMotion® 96 and 96XL

- Semi-automated pipettor for all types of 96 and 384 well plates
- Automatic recognition of EpTIPS Motion tips available with or without filter
- Minimum space requirement
- Downloadable programming and control software
- 10 predefined and configurable methods

- **Standard model:** 0.5 µl to 300 µl available in 1 or 2 positions
- **Model XL:** 5 µl to 1000 µl available in 1 or 2 positions

	96		96XL	
Number of positions	1	2	1	2
Cat. No.	999506	933947	933948	933949
Price	N/A -	N/A -	N/A -	N/A -

EpTIPS Motion tips

Cat. No.	Volume (µl)	Sterile	Filter	PCR clean	Units/box	Price/box
999513	1 - 50	No	Yes	Yes	24 x 96	N/A -
999516	20 - 300	No	Yes	Yes	24 x 96	N/A -
999514	20 - 300	No	No	No	24 x 96	N/A -
933223	40 - 1000	No	Yes	Yes	24 x 96	N/A -
933222	40 - 1000	No	No	No	24 x 96	N/A -

eppendorf



Accessories

Cat. No.	Description	Price
933951	195 ml PCR Clean tank with low dead volume	N/A -
933952	2-position slider upgrade kit for EpMotion 96	N/A -

ZipTip pipette tips

For the concentration and purification of biological samples

The ZipTip unit is a 10 µl pipette tip with a bed of chromatographic media of approximately 0.6 µl attached to the end. It is ideal for concentrating, desalting and fractionating protein, peptide and oligonucleotide samples prior to mass spectrometry, HPLC, capillary electrophoresis and other analytical techniques.

Several resins are available depending on your application:

- C18/µ-C18:
 - desalting and concentration of peptides, proteins or oligonucleotides
 - fractionation of complex mixtures of proteins or peptides
- C4: desalting and protein concentration.
- SCX - cation exchange:
 - purification of peptides
 - removal of detergents

Box with	8	96	960
C18	051168	051177	051182
µ-C18	051169	051178	051275
C4	051170	051465	051183
Price/box	N/A -	N/A -	N/A -
SCX	051468	051368	-
Price/box	N/A -	N/A -	-



Manifold rakes for microplates

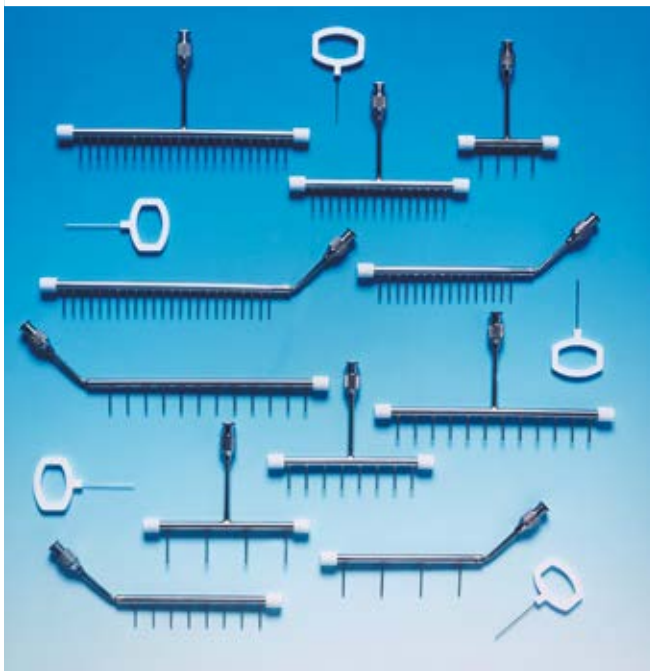

Made of stainless steel and Teflon, these microplate dispensing rakes are inert and autoclavable.

- > For suction and dispensing
- > Luer Lock Connection
- > Supplied with a cleaning tool
- > Tips ext. ϕ x int. ϕ : 0.8 x 0.4 mm



Cat.No	Form	No. of Tips	For plates	Tip space - Tip (mm)	Length Tip (mm)	Price
075028	Right	4	96 well	9	11	N/A -
075029	Right	8	96 well	9	11	N/A -
075030	Curved	8	96 puits	9	11	N/A -
075031	Right	12	96 well	9	11	N/A -
075032	Right	4	24 well	20	17.5	N/A -
075033	Curved	4	24 puits	20	17.5	N/A -
075034	Curved	12	96 puits	9	11	N/A -
075035	Right	24	384 well	4.5	11	N/A -
075036	Right	16	384 well	4.5	11	N/A -
075037	Curved	24	384 puits	4.5	11	N/A -
075038	Curved	16	384 puits	4.5	11	N/A -
075039	Cap for tip	-	-	-	-	N/A -

Drummond calibrated micropipettes - High precision



These highly accurate, flame-polished glass capillaries are rigorously calibrated to within $\pm 0.5\%$.
In a box of 250, with a suction hose.

- > Colour code
- > Printed volume
- > Gauge line

Suction tube

Cat. No.	Description	Price
075056	Suction tube (38 cm)	N/A -

Volume (μ l)	5	10	20	25	30	40	44.7
Colour code	White	Orange	Black	Double white	Double Black	Yellow	Purple/ blue
Cat. No.	075043	075044	075045	075046	075047	075048	075049
Price/ box with 250 units	N/A -	N/A -	N/A -	N/A -	N/A -	N/A -	N/A -

Volume (μ l)	50	75	100	200	100/200	Graduated 1 to 5
Colour code	Green	Violet	Blue	Red	Red	White
Cat. No.	075050	075055	075057	075052	075053	075054
Price/ The box with 250	N/A -	N/A -	N/A -	N/A -	N/A -	N/A -

Calibrated capillary micropipettes Ringcaps Hirschmann



- > In Duran glass
- > Calibrated, colour-coded
- > Certificate of conformity
- > ISO 755, CE according to IVD 98/79 EG

Cat.No	Mark	Volume (μ l)	Units/ box	Price/ box	Cat.No	Mark	Volume (μ l)	Units/ box	Price/ box
090511	5	1 to 5	250	N/A -	-	-	-	-	-
090512	1	10	250	N/A -	090519	1	200	100	N/A -
090513	1	20	250	N/A -	090520	2	5 + 10	250	N/A -
090514	1	25	250	N/A -	090521	2	20 + 40	250	N/A -
090515	1	40	250	N/A -	090522	2	50 + 100	250	N/A -
090516	1	44.7	250	N/A -	090523	2	100 + 200	100	N/A -
090517	1	50	250	N/A -	090524*	1	44.7	250	N/A -

* Heparinized version

Drummond Microcaps

Micropipette-capillaries with total capacity calibrated from end to end by a defined volume.

- High accuracy ($\pm 1\%$)
- Single use
- Borosilicate glass



Pear - silicone tip

Cat. No.	Description	Units/box	Price/box
075180	Pear and tube holder for microcaps	1	N/A -
075181	Silicone capillary end	3	N/A -

Microcaps

Volume (μl)	0.1	0.25	0.5	1	2	3	3-33
Length (mm)	16	32	32	32	32	32	36
Out. ϕ x Inn. ϕ (mm)	0.53 x 0.09	0.53 x 0.09	0.56 x 0.14	0.64 x 0.20	0.76 x 0.28	0.84 x 0.35	0.86 x 0.34
Cat. No.	075069	075070	075071	075072	075073	075074	075075
Price/ the box with 100	N/A -	N/A -	N/A -	N/A -	N/A -	N/A -	N/A -
Volume (μl)	4	5	6	6.66	7	8	9
Length (mm)	32	32	38	42	45	44	49
Out. ϕ x Inn. ϕ (mm)	0.84 x 0.4	0.93 x 0.44	0.9 x 0.45	0.86 x 0.34	0.9 x 0.45	0.9 x 0.42	0.9 x 0.48
Cat. No.	075076	075077	075078	075110	075079	075080	075081
Price/ the box with 100	N/A -	N/A -	N/A -	N/A -	N/A -	N/A -	N/A -
Volume (μl)	10	15	20	25	30	35	40
Length (mm)	41	54	64	65	78	70	46
Out. ϕ x Inn. ϕ (mm)	0.8 x 0.56	0.86 x 0.6	0.9 x 0.63	0.97 x 0.70	0.97 x 0.70	1 x 0.8	1.4 x 1
Cat. No.	075082	075083	075084	075085	075086	075087	075088
Price/ the box with 100	N/A -	N/A -	N/A -	N/A -	N/A -	N/A -	N/A -
Volume (μl)	44.7	50	75	80	100	200	
Length (mm)	52	100	101	91	116	127	
Out. ϕ x Inn. ϕ (mm)	1.4 x 1	1.1 x 0.8	1.3 x 0.9	1.4 x 1	1.4 x 1	1.9 x 1.5	
Cat. No.	075089	075090	075091	075092	075094	075095	
Price/ the box with 100	N/A -	N/A -	N/A -	N/A -	N/A -	N/A -	

Capillaries with other volumes are available on request.

Hematocrit tubes

Glass hematocrit tubes

- Glass capillary hematocrit tubes
- Colour code
- High precision capillary
- Length: 75 mm or 100 mm
- With or without heparin



Cat. No.	Description	Colour code	Length (mm)	Out. ϕ (mm)	Inn. ϕ (mm)	Approximate Volume (μl)	Pack. unit	Price/ pack. unit
090525	Hematocrit tube	Blue	75	1.3 - 1.4	0.9 - 1	60	10 x 100	N/A -
090526	Hematocrit tube	Blue	75	1.5 - 1.6	1.1 - 1.2	75	10 x 100	N/A -
090527	Sodium Heparin Hematocrit Tube	Red	75	1.3 - 1.4	0.9 - 1	60	10 x 100	N/A -
090528	Sodium Heparin Hematocrit Tube	Red	75	1.5 - 1.6	1.1 - 1.2	75	10 x 100	N/A -
090529	Sodium Heparin Hematocrit Tube	Without	100	1.5 - 1.6	1.1 - 1.2	100	10 x 100	N/A -
090530	Ammonium Heparin Hematocrit Tube	Green	75	1.3 - 1.4	0.5 - 0.6	18	10 x 100	N/A -
090531	Wax plate						3	N/A -

Plastic hematocrit tubes 75 mm

Capillary tube made of polycarbonate Plasticrit with a precision comparable to glass. No risk of breakage. These capillaries meet FDA and CDC standards.

Cat. No.	Description	Units/box	Price/box
075127	Polycarbonate hematocrit tube 75 mm	200	N/A -
075128	Heparinised polycarbonate haematocrit tube 75 mm	200	N/A -

Hemato-Clad Mylar coated glass hematocrit tubes

Glass tube coated with a plasticizer, Mylar. Protects the user from glass fragments and aerosols in case of breakage.

Cat. No.	Description	Units/box	Price/box
075129	Mylar hematocrit tube 75 mm	200	N/A -
075130	Mylar heparinized hematocrit tube 75 mm	200	N/A -

Nanoject Drummond microinjectors



Micropipette for injection of nano-volumes.

For electrophysiology, stereotaxis and animal injection.

Equipped with a high-precision positive displacement motor, the Nanoject II micropipette ensures repeatable and accurate dispensing volumes using capillaries.

Nanoject III is programmable for injection volume, speed, number of injections and interval between injections.

Both Nanojects are delivered complete with:

- the injection micropipette;
- the electronic control box;
- 1 capillary box L = 8.8 mm;
- 1 capillary box L = 17.7 mm;
- 1 x 30G needle for capillary filling;
- nanoject universal mounting adapter
- maintenance accessories.

The micromanipulator must be ordered separately.

	Nanoject II	Nanoject III
Range of volumes (nanolitres)	2.3 - 69	0.06 - 999.9
Injection speed (nanolitres/sec)	23 - 46	10 - 200
Programmable	No	8 configurable
O-Ring	3	No
Cat. No.	075058	075250
Price	N/A -	N/A -



Accessories

Cat. No.	Description	Price
075059	Capillary L = 8.8 cm	N/A -
075060	Capillary L = 17.7 cm	N/A -
075062	Needle 30G	N/A -
075063	Optional foot switch for Nanoject II	N/A -
075251	Optional foot switch for Nanoject III	N/A -



Micromanipulator

Micromanipulator adapted to the use of the Nanoject II, with micrometric screw adjustment (1/100th mm).

- X-axis: 37 mm stroke
- Y-axis: 20 mm stroke
- Z axis: 25 mm stroke

It can be mounted on a tilting base or a fixed stand (see diagram).
L x W: 130 x 60 mm.

Cat. No.	Description	Price
075064	Micromanipulator (left-hand position)	N/A -
075065	Micromanipulator (right-hand position)	N/A -
075067	Nanoject Universal Mounting Adapter	N/A -
075068	Fix holder with rods	N/A -

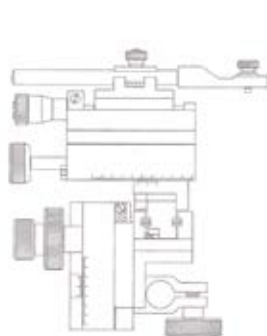

075064

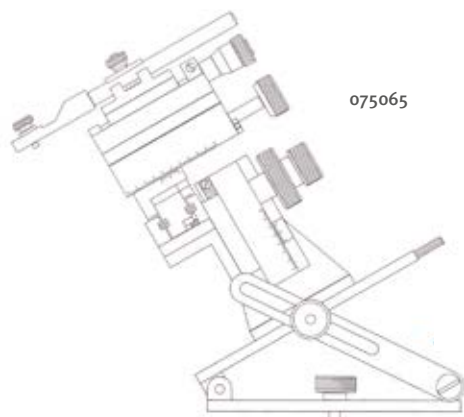

075065

